



Loving music



# THE HEART OF MUSIC



# Contents

Vision and Values .....	04 – 05
Turntables .....	08 – 35
Tonearms .....	38 – 49
Cartridges .....	52 – 59
Electronics .....	62 – 77
Record Cleaning Machines .....	78 – 83
Accessories .....	86 – 97
Company .....	98 – 101
Technical Specifications .....	104 – 115
Imprint .....	119

## ... for the love of music

Perfect composition of precisely coordinated components results in excellent performance, audiophile authenticity, and leading edge quality.

If everyone achieves their best and contributes to the overall picture, then new superlatives become possible. This is what connects and pushes us every day.

After more than 40 years, the Clearaudio brand continues its history, operated as a family business. Our management trio of siblings share their love of music, enthusiasm for the steadily growing vinyl community, and the passion for our high-end manufacture in Erlangen, located at the center of research and technology.

Together with our fantastic team, we are responsible for what electrifies this community and makes them listen up. Music

reproduction from vinyl records that, thanks to its realism, involves us like a live concert. All positions within our team are mastered through talent and experience – always committed to the company philosophy:

“Take the best, make it better -  
Only then it is just good enough.”

For this reason, Clearaudio can consistently optimize the real-life musical experience to fulfill what our customers expect. And we feel obliged to meet those expectations.

We have respected this belief since we founded our manufacture in 1978, the year our first moving coil cartridge was developed and patented. From that point on, we have continuously improved our premium models, utilizing our in-house specialists to make an audiophile sound for everyone.

Our concept series is most extraordinary and best sounding for young vinyl fans and their budgets. The options for improvement remain, for example, by choosing a higher quality cartridge or specialized power supply.

Another creed we put into action: It doesn't matter what style of music touches you. Clearaudio technical always signifies the pure enjoyment of a life performance and a solid investment for generations to come.

At Clearaudio we embrace analog audiophilia as a whole, with first-class turntables, tonearms and phono cartridges. We pay particular attention to the choice of materials, from polished diamonds on boron needle carriers to micro-wire gold coils, ceramics, and armoured “panzerholz” wood. In addition, our selection extends from excellent pre-amplifiers to a wide range of accessories, including record cleaning machines, plus plugs

and cables, for extended listening pleasure. Our Clearaudio music division, includes new releases, re-issues, and our own analogue recordings on vinyl, completing the portfolio of our family business.

It is about loving music. The vinyl market, once believed dead, continuously increases in yearly growth. Our company Clearaudio inspires both music lovers and technology fans around the world in more than 80 countries. They are seeking live sound quality, raising the bar a little higher with every innovation.

Everything literally results in “hearing sense” – music coming alive with breath-taking designs that prove that acoustic masterpieces go hand in hand with aesthetic craftsmanship.

Electrify the music you love: Experiencing it in your home as from the best seat at a live concert.



Patrick Suchy, Veronika Suchy, Robert Suchy (f.l.t.c.)

# Emotion – Live



# Statement V2

Take the best and make it better, only then it is just good enough.

Based on this philosophy, Clearaudio has been setting new standards in analogue music reproduction for more than 40 years. Based on their shared love for music, Robert, Patrick and Veronika Suchy have designed an exceptional new turntable that breaks the rules and boundaries of music reproduction. The results of their tireless passion and commitment are the outstanding Statement V2 turntable and the Statement TT1 tangential tonearm, designed to reproduce music from vinyl records at the highest possible level. The Statement V2 turntable combines unprecedented functionality, beautiful design and superb engineering with innovative patented Clearaudio technology.

This fusion of extraordinary craftsmanship, attention to the smallest details and elaborate state-of-the-art production reflects the creative values of the Suchy family and their on-going passion to build innovative turntables at the highest level that are inspiring and set new standards of performance.

Even the most minute musical details are faithfully reproduced. Nothing is added, coloured, distorted or lost. Let your ears relax as they hear only the music, the whole and complete musical performance.

Discover another dimension of music reproduction.



# Statement V2

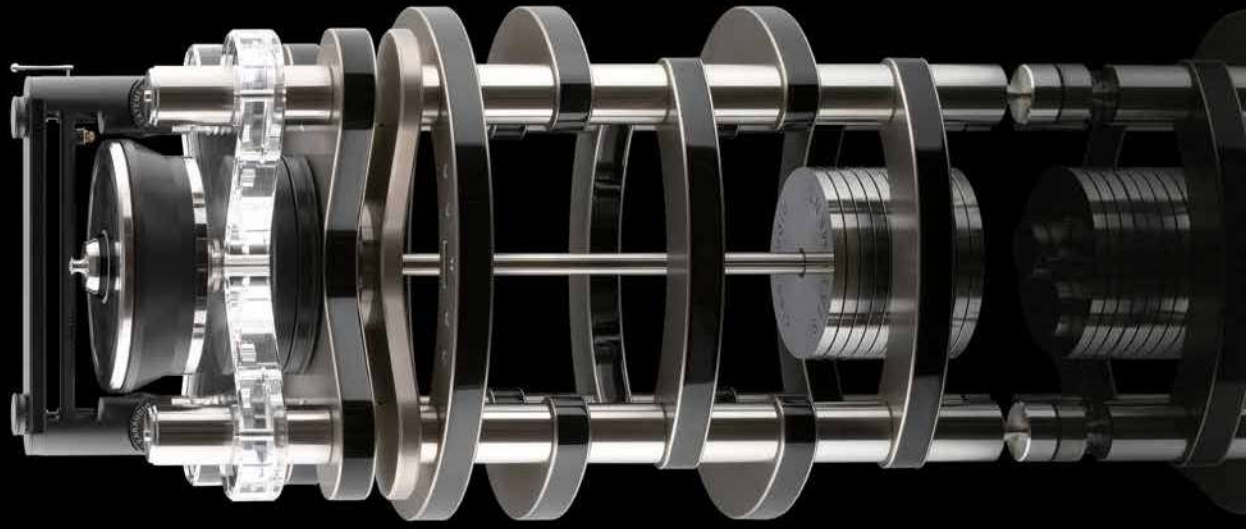

# Statement TT1



They call it the pinnacle of analogue music reproduction. The patented Statement TT1 tangential tonearm developed by Clearaudio has been copied many times, but never matched. As its name implies, the TT1 represents the ultimate statement in tangential tonearm construction. This pinnacle of tangential technology is a key yardstick for Clearaudio's development team. With the Statement TT1, records are played as they were cut – in a straight movement with no curves. Hence the cartridge's stylus tracks the record groove perfectly without errors. In addition, Clearaudio uses a unique passive technology:

A self-sufficient tonearm drive with a purified mechanical design was created to combine optimal resonance values with maximum freedom from interference in the transmission of the music signal. In the TT series, Clearaudio uses accurately crafted high-quality materials that are subject to ongoing quality control. Stability and value come first. Uncompromising consistency and ongoing innovation and development make Clearaudio a pacesetter in tangential tonearm technology, always moving towards the perfect audiophile listening experience.



Patented non-contact magnetic drive



Precise arm height adjustment allowing fine tuning of VTA, even during playback



Self-leveling mechanism with massive stainless steel pendulum



Damped, floating main chassis

# Turntable technology at its finest

The goal of high-end analogue is to perfectly merge technology, workmanship and design and subordinate them to one single target: The best possible music reproduction. At Clearaudio, all development, design and production remain firmly in the hands of a perfectly experienced and attuned team of specialists who never lose sight of that goal, and who uphold the Clearaudio philosophy and high-quality standards.

From the finest part to the full audiophile 'Gesamtkunstwerk' (a complete work of art that draws on many art forms), at Clearaudio everything is meticulously made by hand – with maximum precision and plenty of passion. Precision-crafted mechanics and the use of components fine-tuned for density, mass and shape guarantee mechanical harmony and the absence of resonance when playing records. The ingredients are high-density bullet proof wood, titanium, stainless steel, V2A, aluminium and specially developed high-performance plastics. Two parameters are of critical importance: Maximum performance of music playback and technically effective design, as well as the aesthetic beauty of our creations.





# Master Innovation - Masterfully optimised

The biggest model in the popular Innovation series shows clearly how even the best is constantly being further developed and brought to new sonic heights at Clearaudio. The 70mm thick, dynamically balanced platter made of resonance damping plastic with a 15mm thick precision-machined stainless steel sub-platter delivers the highest mechanical standards. The Master Innovation doubles the inertia of the Innovation. Incredible rotational speed stability is achieved thanks to the combination of the patented Clearaudio ceramic magnetic bearing (CMB) supplemented by an additional flywheel and a high-torque DC motor.

An infrared sensor sends signals to an optical speed control mechanism to consistently maintain the perfect speed, while non-contact magnetic decoupling of the drive prevents any motor system vibration or noise from reaching the main turntable. Consequently, speed variations are eradicated and perfect pitch is obtained.

The Master Innovation provides the ability to mount up to three tonearms. Existing Innovation owners have the option to upgrade to Master Innovation level.



Master Innovation, black with TT1 MI tonearm



Speed selection and motor control



Possibility to install up to three tonearms, picture shows Clearaudio TT2 tangential tonearm



Contactless drive through magnetic platter



Possibility to install up to three tonearms, picture shows Clearaudio Universal radial tonearm



Master Innovation, wood with TT1 MI tonearm



Master Innovation, wood with TT2 tonearm

# Innovation - Perfect synchronisation

In the world of turntable construction, the Innovation is the ultimate technological prototype. An infrared sensor combined with Clearaudio's optical speed control (OSC) ensures an outstanding level of speed stability – a prerequisite for optimal listening. A high-torque decoupled DC motor effortlessly rotates the precision-machined 70mm thick platter made of high-density acrylic.



Clearaudio da Vinci V2 MC cartridge



Detail of Clearaudio Universal tonearm and VTA-lifter



Innovation, black with TT3 tonearm



Speed selection and motor control

Detail of CMB drive unit



Innovation, wood with Universal tonearm



## Innovation Compact - Efficient by design

Perfectly matched materials meet patented Clearaudio technology. The 70mm thick platter of the Innovation Compact consists of dynamically balanced polyoxymethylene (POM) and is powered by a high-torque DC motor with precision bearings, developed exclusively for Clearaudio. The Innovation Compact turntable with its very efficient design is nothing less than an audiophile revelation. Thanks to optical speed control (OSC), speed stability values are obtained that lift this turntable into the global high-end class. The optimally designed chassis keeps resonances out of the audible range and guarantees maximum stability in a housing made of a massive bullet proof wood and aluminium sandwich. Timeless design with quality built to last for decades. The option to mount a second tonearm makes it possible to play a rich variety of music from across the decades.



## Innovation Basic – Ticket to the top of the world

The Innovation Basic turntable brings forth a new class of Clearaudio technologies. This model benefits from the advanced design features of the Innovation turntable - but in a minimalist design. The Innovation motor control (OSC = Optical Speed Control), developed by Clearaudio, ensures a constant speed of the turntable and allows a comfortable selection of individual speed levels. Combined with the patented Clearaudio ceramic magnetic bearing technology (CMB), the world's most accurate speed measurements are reached. The horizontal position of the platter can be achieved by fine adjustment of the height-adjustable turntable feet. Technical details like the precision drilled 38mm polyoxymethylene (POM) platter and an exclusively DC motor are the seminal quality features of the Innovation Basic turntable. Due to two solid armboards the installation of two tonearms is possible. The Innovation Basic is also available in the sublime bullet proof wood version, the hardest wooden compound so far, in order to achieve music output in perfection.



# Ovation - Classical elegance

Within a precision-machined chassis comprising a sandwich of aluminium and bullet proof wood, 100,000 tiny metal balls eliminate any possibility of harmful resonances. Hidden under a 40mm thick platter made of resonance-damping polyoxymethylene (POM) is a very quiet decoupled DC motor with high-torque. The design of the Ovation seems both timeless and minimalist – maximum music enjoyment needs no embellishment. With Clearaudio's optical speed control (OSC) and ceramic magnetic bearing (CMB), the Ovation achieves supreme speed stability and redefines the standards in its class. Audio Journal 'The Absolute Sound' recognised the Ovation's superior qualities and declared it 'Turntable of the Year 2011'.



Convenient speed control at the push of a button



Silver anodized aluminium surface



Magnetically floating aluminium precision sub-platter



Ovation, black with Tracer tonearm



Ovation, wood with Clarify tonearm

# Reference Jubilee Anniversary turntable

[limited  
250  
edition]



Reference Jubilee,  
with TT3 tonearm

The new Reference Jubilee turntable marries the best of Clearaudio's 40 years of excellence to usher in a new era of analogue precision. It delivers synchronized rotational speed, astonishingly low levels of both resonance and friction, and a breathtaking moment of torque.

Its 6cm-thick main platter is constructed from highly damped polyoxymethylene (POM) and, as you might expect with any Clearaudio turntable, the platter rotates on a special variation of our own patented ceramic magnetic bearing (CMB). The motor housing is elaborately decoupled from the chassis by an innovative network of rubber "tightropes" ("IMS").

While Clearaudio has earned a considerable reputation for innovation in all things analogue, here the design team has expertly married digital and analogue technology to achieve a

new level of precision and consistency of rotational speed. A 12-bit DAC generates the drive motor's voltage; the DAC has exceptionally high resolution and zero fluctuations or "drift" in response to either time or temperature. What's more, it has been cleverly designed to work in tandem with Clearaudio's optical speed control system. Every three seconds, an optical sensor takes a reading of the 8.5kg stainless steel sub-platter's rotational speed, and delivers that reading to a control unit. The control unit then immediately regulates the slightest deviations by adjusting the motor's voltage via an operational amplifier.

The Reference Jubilee's brand new air-core (non-magnetic) 24-volt DC motor runs unbelievably quietly, ensuring that the listener remains blissfully unaware of the whole process.

The new developed Professional Power 24V linear power supply is already included.



Elaborate suspension design  
of the motor (IMS - Innovative  
Motor Suspension)



Reference Jubilee speed change



Limited edition - Only 250 units



Clearaudio Professional  
Power 24V



# Performance DC - High-end for all

The Performance DC is a turntable designed to open up the high-end listening experience to those ambitious music lovers who are willing to handle the basic features of tonearm and cartridge adjustment, and who simply seek the best in music reproduction. A newly developed DC motor with high-precision bearings and flat belt-drive, in conjunction with a platter of 40mm thick POM which rests on a Clearaudio ceramic magnetic bearing (CMB), provide optimal conditions for the correct sampling of the record groove.

Excellent tracking properties and hyper-accurate speed synchronisation ensure the ultimate listening pleasure, regardless which Performance DC package you choose. The wide range of Clearaudio tonearms and cartridges offers almost infinite combinations that leave nothing to be desired.

Also the endless color combination of the Performance DC makes hearts beat faster.



Performance DC, black / black with TTS tonearm and swing base



Magnetically floating aluminum precision sub-platter



Detail of Clearaudio radial tonearm headshell



Performance DC, black / black with acrylic platter



Performance DC, silver / white



Performance DC, rose gold clearacryl wood with Tracer tonearm



Performance DC, silver / silver with Clarify tonearm



Performance DC, silver / black with Clarify tonearm



Performance DC, black / silver with Clarify tonearm



Performance DC, black / wood with TTS tonearm



Performance DC, silver / wood with TTS tonearm and swing base

# concept

Clearaudio's vision for the concept: Design an elegantly styled turntable package featuring a level of ground-breaking technology usually only found in high-end turntables, combining plug-and-play simplicity with outstanding sound quality and affordability. The concept achieves these highest of requirements, realising the Clearaudio vision.

Beneath the sleek, contemporary exterior is a level of technical sophistication unique to Clearaudio. The concept's body is carefully crafted from medium-density wood fibre (or, optionally, pressure-formed solid wood) with a selection of smart made-to-match surface finishes. The body's upper layer incorporates a special high-tech satined plastic compound designed to minimise unwanted resonance.

The DC motor is fed by an external voltage-stabilised power supply and is completely decoupled from the chassis, isolating the record from any mechanical interference. The concept tonearm features a magnetic bearing that is friction-free for extremely low distortion and superb performance.

The package is completed with the high-quality Clearaudio concept MM or Clearaudio concept MC cartridge. With the concept turntable package, Clearaudio offers you an extremely innovative design that is very affordable.





# concept active - One for all, all for one

The concept active features an integrated Clearaudio phonostage and headphone output with volume control directly on the turntable, giving you everything you need to enjoy your favourite records without having to add additional equipment. The excellent integrated headphone amplifier is suitable for all good quality, dynamic headphones and active speakers.

If you prefer to listen through loudspeakers or want to share your music with friends, simply plug your regular amplifier into the RCA socket at the rear of the deck. The integrated phonostage can also be switched off in order to use your own.

The concept active package is available with either our frictionless, magnetic bearing concept tonearm or our award-winning, direct-wired Satisfy Kardan Aluminium tonearm.

To round off the package, choose either the concept MM or concept mc cartridge.

All of the concept active's key parameters from tracking force to anti-skating are fine-tuned as part of the manufacturing process, leaving you nothing to do but sit back and enjoy.



concept active volume control



Headphone output



concept active, rear view



concept active,  
silver with Satisfy Kardan tonearm



concept active,  
black with concept tonearm

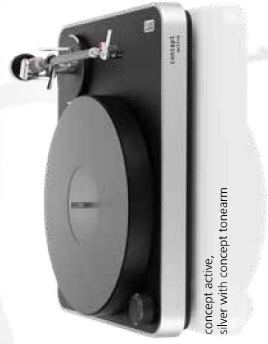

concept active,  
silver with concept tonearm



concept active,  
dark wood with concept tonearm



concept active,  
wood with Satisfy Kardan tonearm

# concept - For open ears and eyes

The revolutionary concept combines the highest quality of music playback with a design that has won several awards worldwide – including the German Design Award and 'Best Turntable' award from 'What Hi-Fi? Sound and Vision' magazine. With the concept, to find an affordable entry point to the high-end world is a breeze. It reveals the magic of optimum sound reproduction even for those music lovers who could not previously afford this experience. You can buy the concept in a package with specially developed moving magnet (MM) or moving coil (MC) cartridges.

The concept represents the ideal of stress-free 'plug and play': Unpack, connect, put the record on the platter – and just enjoy music. There was never more audiophile technology in this class of turntables.



Convenient speed and motor control



Clearaudio concept radial tonearm with frictionless magnetic bearing



Clearaudio concept mc cartridge



Precision aluminum sub-platter



concept, dark wood with concept tonearm



concept, wood with concept tonearm



# Pure feelings

# Tonearms

Here at Clearaudio, we have developed new and better ways of satisfying the audiophile's needs. We offer an unparalleled selection of the three main types of tonearms: Single point bearing radial, multi-point bearing radial and tangential tonearms. Our range of tonearms features many cutting-edge technologies, including several Clearaudio patented designs. Even the radial tonearms deliver ground-breaking technology and include many patented systems such as our magnetic bearings, as well as precision ball-face, unipivot, gimbal, and hybrid bearings.

Our sophisticated tangential technology is the perfect solution for those who really want to engage completely with the music and experience a flawless rendering of all facets of sound. Each LP master is tangentially cut in production by the record-cutting lathe. Clearaudio tangential tonearms operate according to our patented, purely mechanical passive process and follow the exact same tracking path as the cutter head that made the master. Replay tracking angles are thus identical and so mistracking distortion is virtually eliminated.



# Statement TT1 & TT1 MI - Tangential tonearms: One becomes two

They call it the pinnacle of tangential tonearm technology: Clearaudio's patented Statement TT1 has been copied many times, but never matched. Now this state-of-the-art tonearm has been further enhanced and reengineered as two distinct editions: The Statement TT1, designed specifically for the Statement V2, and the TT1 MI, tailored for the Master Innovation and Innovation turntables.

With the Statement TT1 and TT1 MI, records are replayed exactly as they were cut – following a straight line across the record. The cartridge's stylus is positioned at a perfect tangent to the record groove, guaranteeing zero tracking error. No skating force is generated at playback so no anti-skating compensation is needed. In both editions, Clearaudio use a unique passive technology. The self-driven tonearm is mounted in a suspended carriage, a purely mechanical design that combines optimal resonance values with

maximum freedom from interference in the transmission of the music signal. The new Statement TT1 and TT1 MI now also feature an enhanced arm carriage, designed to further reduce friction. In addition, the suspension of the carriage has been adapted to enable the use of more shallow-bodied cartridges.

Only the finest materials earn their place in the Statement TT1 and TT1 MI. The resonance-optimised chassis is precision machined from bullet proof wood and aluminium. It glides backwards on stainless steel rails to allow record changing, then slides effortlessly back into the playback position and is held there with a magnetic locking system.

Uncompromising consistency and ongoing innovation make Clearaudio a pacesetter in tangential tonearm technology, always moving towards the perfect audiophile listening experience.



TT1 MI headshell



TT1 MI height adjustment



TT1 MI level gauge



TT1 MI lift arm



TT1 MI detail



TT1 MI tangential tonearm, black



TT1 MI tangential tonearm, silver

## TT2 - Precise masterpiece

It takes hours to assemble the TT2 tangential tonearm. Clearaudio invests masterful production quality in this fine mechanical work of art, the basis for a hard to beat sound quality. The purely mechanical precision drive of the TT2 is based on two dry-running high-precision bearings and a polished glass tube that ensures almost complete freedom from friction. The subtle finish in silver or black aluminium crowns the TT2's highly functional design.

This tangential tonearm with its weight of nearly two kilograms is completely stable, can be finely adjusted in height and is elegantly simple to use.

A massive masterpiece that transmits the information extracted from the record groove more precisely and faithfully than ever before, with a decisive impact on the authenticity of the music playback.



TT2 tangential tonearm,  
black

TT2 tangential tonearm,  
silver



Elegant cueing and precise height adjustment



TT2 cartridge carrier

## TT3 - High-end introduction

The TT3 tonearm embodies the Clearaudio philosophy of uncompromising optimisation of the playback of records.

It embodies total mechanical control and requires no power assistance. This guarantees a flawless musical signal without noise. Polished glass and extremely smooth bearings provide friction free movement of the cartridge and minimum resonance.

The TT3 is available in silver and black finish.

The TT3 shares with its bigger brothers in the TT range an integrated mechanism for fine height adjustment and elegant cueing. Experience the power of audiophile music reproduction with an astonishing lack of distortion – hear music in its purest form without compromise.

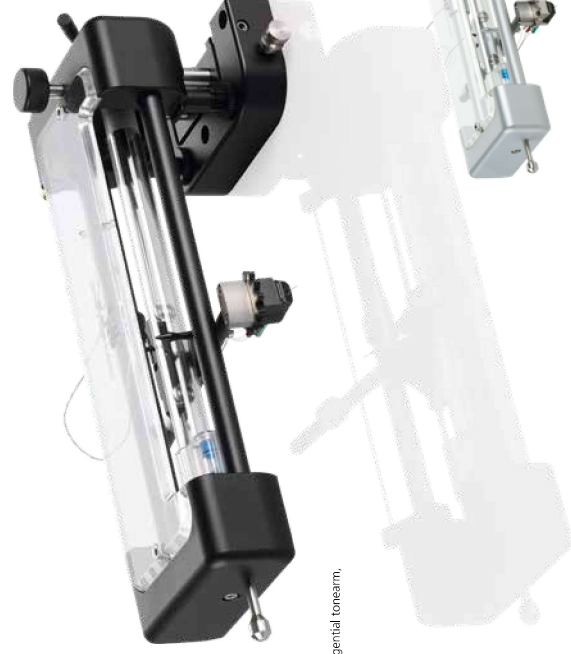

TT3 tangential tonearm,  
black

TT3 tangential tonearm,  
silver



TT3 cartridge carrier



Bubble level for precise tonearm adjustment



Elegant cueing and precise height adjustment

# TT5 - High five

With the TT5, Clearaudio offers vinyl fans a more affordable entry point into tangential tonearm technology. The TT5's surprising and excellent value for money is down to eschewing one or two of the features of its bigger siblings, the TT2 and TT3. For example, the TT5 adopts a new, fully rigid design. However, for

those who like it convenient, Clearaudio has created the optional TT5 swing base which, as its name suggests, allows the entire arm assembly to be moved out of the way when changing records. Review magazine "Audio" included the TT5 in its analogue highlights of 2015.



TT5 tangential tonearm, black



TT5 tangential tonearm, silver with swing base



Swing mechanism of TT5 in combination with swing base

# Universal - Lightweight stability

A mechanical masterpiece of both design and functionality, Clearaudio's Universal (also compatible with VTA-Lifter) convinces by performance. High-precision ball bearings in the vertical and horizontal axes guarantee that the tonearm provides the perfect conditions for the cartridge to track the record groove without adding any colouration or distortion. The arm tube is made of carbon, ultra stiff but lightweight, providing maximum stability and perfect tracking. The easy and exact setting of azimuth

and VTA are child's play – and with the optional VTA-Lifter the adjustment of VTA can be done even while playing a record. The Universal is compatible with almost all popular cartridges, thanks to easily interchangeable counterweights and a fine scale which makes the precise adjustment of tracking force elegantly simple. The Universal is available in 9 inch and 12 inch lengths each in the colors silver and black. As an optional extra the VTA-Lifter is available in the corresponding colors.



Universal 9 inch tonearm, silver carbon



Universal 9 inch tonearm, black carbon with VTA-Lifter



Tonearm headshell and da Vinci V2 MC cartridge



Tonearm tube, made from equally lightweight and highly rigid carbon fibre



Any weight of cartridge can be compensated by the easily interchangeable counterweights



VTA-Lifter

# Magnify - New standard

Its hybrid bearing on high-precision balls and magnets make the Magnify tonearm something special. This innovative design not only ensures interference-free and resonance optimised playback, it also noticeably simplifies setup and adjustment. The headshell and azimuth can be easily fine-tuned and with the optional VTA-Lifter it is possible to adjust the VTA even during playback. The Magnify is the result of careful optimisation to fully exploit the

advantages of the extremely lightweight carbon fibre material. This tonearm defines the standards – not least because it is compatible with many cartridges. It is equipped with a high-quality Clearaudio wire in a continuous run from the cartridge connectors to the tonearm cable plugs. A tonearm that stands for ultimate sound clarity.



Magnify tonearm,  
Silver carbon



Fine adjustment of the antiskating and the tracking force



Innovative hybrid bearing with magnetic and high-precision ball races

# Tracer - Elegance meets ease

The Tracer radial tonearm may look beautifully minimalistic, yet beneath its sleek design you'll find a wealth of workmanship and a raft of smart details. Drawing on engineering tricks from the finest watchmakers, it features a high-precision, low-friction jeweled bearing, judiciously crafted from tungsten and sapphire. The carbon tonearm tube is both extremely rigid and very lightweight, giving a perfect combination of stability and agility. What's more, the Tracer's elegance does not come at the expense of usability – on the contrary.

The anti-skating force is effortlessly adjustable by way of a simple dial within perfect reach, while the aluminium headshell allows the azimuth to be easily fine-tuned. The counterweight is underslung providing an optimal centre of gravity and allowing straightforward adjustment of the tracking force. The Tracer is available in a choice of silver carbon or black carbon.



Tracer tonearm,  
Silver carbon

Tracer tonearm,  
black carbon



Tracer radial tonearm,  
black carbon



Detail of Tracer tonearm,  
black carbon



Detail of Tracer tonearm,  
silver carbon



## Unify - High performance in a nutshell



The Unify tonearm represents the summit of unipivot radial tonearms, and stands out not only for its elegant looks. A sapphire bearing and a hardened, precision polished steel tip are at the heart of a tonearm made of the best materials - and probably one of the best unipivot constructions in the high-end audio history. The base consists of a stainless steel pillar, the arm is made of carbon fibre and the bell is made of aluminium. This clever mix of materials guarantees resonance-free behaviour

resulting in seemingly gigantic sound spectra of vivid colours and rich detail. Effective weight reduction ensures that the friction in the single-point bearing approaches zero. The vertical and horizontal tracking angle are adjusted separately. A proven Clearaudio tonearm cable used in the Unify provides an unbroken signal path. Any passionate audiophile cannot fail to be enchanted by the Unify. This exceptional tonearm is available in 9, 10 and 12 inch lengths.

## Clarify - Smooth pleasure



If mechanical parts do not touch, there can be no friction. The Clarify tonearm uses magnetic bearings and is therefore completely frictionless. This Clearaudio innovation transmits even tiny signals without any interference and remains absolutely unaffected by resonances. The Clarify can be used with virtually

all cartridges with a weight from 2.5 to 17 grams, but reaches its maximum performance potential and richest sound when combined with the Ovation turntable and a Clearaudio moving coil (MC) cartridge.

## Satisfy Kardan - Direct to the heart



At the heart of the Satisfy Kardan is something quite significant: Direct wiring, which allows the audio signal to travel uninterrupted and unimpeded along one single continuous path from cartridge to preamplifier. What's more, thanks to a pre-mounted aluminium headshell, the azimuth is a breeze to align. Anti-skating? Equally effortless, yet reassuringly precise. Magnetically adjusted, it is then fixed in place with an easily accessible locking screw neatly positioned next to the tonearm bearing. The vertical bearing features a polished tungsten spindle embedded in a meticulously balanced sapphire bearing (the latter

is also used by Swiss clock manufacturers - which gives you an idea of its accuracy). The two horizontal bearings are crafted using an exceedingly strong and durable ceramic material. Strong and durable it may be, but the Satisfy Kardan has also been designed for flexibility - in that it is combinable with a wide range of turntables and cartridges, allowing you to incorporate it into your current system with ease.

Whether you opt for the silver, black aluminium or carbon fibre edition, the Satisfy Kardan will get direct to the heart of your music.

## Verify / concept - Elegant listening



The Verify tonearm presents Clearaudio's innovative and groundbreaking magnetic bearing technology in an elegant package. Super solid, resonance-optimised carbon fibre is the basis for a user-friendly radial design. The aluminium resonance-free headshell can be finely adjusted; the finely adjustable counterweight sets the exact tracking force. Stylish design and clean lines make the Verify a stunning eye catcher as well as providing precise signal transfer and a calm, clear sound. This beauty is wired with a Clearaudio high-quality cable.

By combining the design of the Verify tonearm with a black aluminium tonearm tube, the concept tonearm was created and is now an essential part of the Clearaudio portfolio. This tonearm reaches its optimum sound when combined with the concept turntable and corresponding concept mc cartridge. For high-end music lovers and newcomers, this may be the most exciting complete turntable package of all time. But even on most other turntables the Verify embodies an affordable synthesis between breath-taking design and detail-rich sonority. Cartridges with a weight from 2.5 to 17 grams are ideal partners for the Verify.



# Amazing stage

# Cartridges - Close to the mystery of music

Clearaudio have been engaged in ongoing research into moving coil technology since 1978. Compared with moving magnet systems, moving coil cartridges have the potential to extract even finer details from the record groove and to respond to dynamic changes significantly faster. Since the early days of our research, the improvement of sound quality has been driven steadily forward by using new materials and seeking new solutions to well known problems, such as setting new standards in the parameters of dynamic impedance, inductance and capacitance. Ingenious design and extensive scientific experimentation have allowed us to bridge the gap in performance between moving magnet and moving coil cartridges. Our top-of-the-range moving magnet cartridges incorporate many of the features of our moving coil cartridges. The Clearaudio MC generation V2 represents the state of the art for high-end MC cartridges.

Perfect symmetry for perfect sound reproduction:  
Clearaudio moving coil cartridge technology.

Only patented Clearaudio moving coil (MC) cartridges are symmetrical in all three important respects: Magnetic, mechanical and electrical. Clearaudio MC technology is considered by both experts and music lovers to be the ultimate in audiophile music reproduction.

Since Clearaudio was founded in 1978 the team have pioneered a series of novel ideas, subjecting every new development to meticulous scientific examination and ruthless testing. This tireless refusal to accept limitations and to strive toward new solutions and higher fidelity have enabled Clearaudio to reach peaks of innovation and technological development and to occupy a leading market position.

Such outstanding specifications as a dynamic range of 100 decibels and a bandwidth of 20Hz - 20kHz speak for themselves. Countless hours are invested in our laboratories to make Clearaudio's flagship products even better and in so doing, the standard for the world's best to be redefined and many technological triumphs of analogue music reproduction have been achieved.

Each moving coil cartridge made by Clearaudio is an impressive demonstration of fine engineering and a milestone in high-end audio history: Unique masterpieces with microscopic pure gold coils, handmade in Germany.

## Goldfinger Statement - The ultimate dream

This cartridge deserves to play the best recordings of all time. In order to 'feed' the moving coil (MC) Goldfinger Statement with adequate music material, Clearaudio founded a music production department specialised in audiophile recordings of all genres. For the first time in a cartridge, the Goldfinger Statement features perfectly matched and symmetrical magnets enabling the system to reach a dynamic range of 100 decibels. For the Clearaudio engineering team this represents the fulfilment of an audiophile dream that seemed long unattainable. The Goldfinger Statement is also the first cartridge with integrated RF shielding.

The outstanding sound quality of this world-class cartridge is the stunning result of meticulously detailed development and finetuning of all important criteria. The breakthrough came with the use of a 30 per cent thinner 24 carat gold wire for the coils, a precision-milled gold mounting for the magnet array and a body made of solid 14 carat gold – essential core components for the ultimate cartridge masterpiece. The high-quality Clearaudio Prime Line stylus shape provides the best detail retrieval of all time. A flawless diamond on its face beautifully adorns the Goldfinger Statement.  
Clearaudio calls this miracle of a cartridge our "magnum opus".



Images enlarged for viewing

## Titanium V2 - A jewel for your eyes and ears

This exceptional cartridge represents a work of art for the ages: Its 95 decibel dynamic range delivers the optimum for current listeners and may well also set a benchmark for future generations. Through its technical perfection, the Titanium V2 embodies perhaps the most exciting combination of materials in audiophile history. Perfect resonance suppression is embodied within the twelve-finger plattform design, which has become a standard-setter for aesthetic as well as functional design.  
Thanks to the boron cantilever, Clearaudio Prime Line stylus shape and 24 carat gold coils in conjunction with a titanium body that weighs just eight grams, the highest linearity and transparency of analogue playback can be achieved with this gem of a cartridge. Audiophile dreams become audible.



## da Vinci V2 - Innovative classic

Classic design for contemporary art, which represents the current state of what is possible. The aluminium body of the da Vinci V2 is characterised by its extra hard, 30 micron thick ceramic coating that delivers extremely efficient resonance suppression. Its interior is so unique that it has been patented: Eight magnets that provide massive focused field density guarantee perfect reproduction of audiophile recordings. The 24 carat gold coils of the da Vinci V2 are arranged in circular symmetry. This cartridge is an excellent example of combining cutting-edge research with meticulous craftsmanship to deliver outstanding results.  
With a total weight of only seven grams, Clearaudio Prime Line stylus shaped, rigid boron cantilever and 90 decibel dynamic range, the da Vinci V2 provides all that is required to open up new horizons of sound dynamics and tonal homogeneity.



Images enlarged for viewing

## Jubilee MC – Anniversary masterpiece

The new Jubilee moving coil phono cartridge is the first Clearaudio cartridge with a body created from Panzerholz, a high-tech, natural wood product manufactured in Germany. This remarkable material already contributes to the exceptional performance of a number of our turntables, thanks to its high-density, high-strength and extremely low resonance. And yet, despite being dense enough to sink in water and strong enough to be bullet proof, Panzerholz is also surprisingly light in weight. Add to this a very special paint and polish finish borrowed from the elite violin makers of our local area, and you have a very fine 'musical instrument' indeed - a true marriage of cutting-edge technology and acoustic craftsmanship.

## Stradivari V2 - The height of precision

A name to live up to. Meticulousness of design, spurred on by a goal of redefining the best and raising the bar ever higher, have led to a masterpiece of German craftsmanship. An impressive 80 decibel dynamic range is made possible through the use of patented V2 technology and of the finest high-end materials. This lightweight precision cartridge weighs only seven grams. It is the result of highly devotional microscopic craftsmanship – mastery of perfection in design and material selection. Important ingredients are a body of long-aged ebony, a precisely ground twelve finger platform and coils of 24 carat gold. The result: A stunning listening experience of almost unbelievable transparency and depth.

## Concerto V2 - In the league of champions

With a dynamic range of up to 70 decibels and a total weight of only seven grams, the Concerto V2 qualifies itself for the top league of moving coil cartridges. Within this satin wood body the technology is outstanding, housing 24 carat gold coils and a patented eight-magnet array unique to our V2 range. Further champion-level ingredients are the boron cantilever and Clearaudio Prime Line. A recipe to win the trophy of sound championship.

## Talisman V2 Gold - Simple, elegant, great

Due to its patented symmetrical arrangement of eight magnets and 24 carat gold wire coils the new Talisman V2 Gold redefines the performance available at this price level and reveals the sonic potential of the second generation 'V2' series of Clearaudio moving coil cartridges. The legendary combination of a rigid boron cantilever and Clearaudio Prime Line diamond shape extract even the finest details stored in the record's groove both effortlessly and meticulously to deliver an unprecedented performance. The 10.8 gram hand-polished ebony body not only impresses with its discreet elegance, but also contributes to the clear, captivating sound of this cartridge by perfectly suppressing resonances.

## essence mc - The essence of music

Take the best and make it better"... sometimes the Clearaudio motto proves to be quite a challenge. Especially when it calls for a brand new cartridge design that will improve upon our entry-level concept mc cartridge but without breaking a key price point! How did we do it? By taking the 'essence' of the concept mc design and applying even tighter controls to every element of its construction. The boron cantilever, the Micro line stylus and of course the clever arrangement of the magnets have been subjected to the most stringent scrutiny, thus ensuring superb dynamics, fine resolution and channel matching of better than 0.3dB. The electrical parameters are such that the essence mc will match with almost any MC phono stage, guaranteeing superb results: Natural tonality, three-dimensional sound-staging, vivid dynamics and captivating musicality. That's the essence of our new MC!

## concept mc - Reduce to the maximum

The concept mc combines high-quality moving coil technology with a minimalist design. Here, audiophile explorers discover what the optimisation of magnetic circuits can deliver: This cartridge releases crystal clear sounds and represents nothing less than a revolution in its class. Equipped with a boron cantilever, the concept mc has channel matching to within half a decibel, 11 ohms internal impedance and is fitted with a Micro line stylus – features normally unheard of in this price range. All of which adds up to make this high-quality cartridge a bargain for the cost-conscious high-end fan.

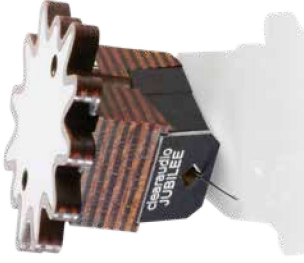

Images enlarged for viewing

Images enlarged for viewing

# MM cartridges

Clearaudio's V2 MM technology uses ebony as a resonance-resistant body. Other ingredients of the recipe for success are the most effective reduction of moving mass, an optimised polishing technique for the stylus and highly effective cartridge damping. This is precision engineering in the pursuit of the best sound.

The Clearaudio V2 moving magnet cartridges are meticulously measured, analysed, and hand-selected into four performance levels. In this way Clearaudio achieves the best stereo channel matching, minimum phase error and distortion, flattest frequency response and highest dynamic range at each price point. The cartridges produce an audiophile sound of superlative quality – spatially detailed and vividly textured, with bass that does not wallow and treble that is not harsh. The models of the Clearaudio MM V2 series provide outstanding sound quality on all current tonearms.

With the exception of the concept V2, which is made of aluminium, all the cartridges of the V2 series are made with housings of hand-polished ebony – the key to record-breaking weight values with an average of 8.4g. This is what Clearaudio calls: "effective reduction of moving mass".

Like the new Jubilee MC, our moving magnet / MM edition also features a body expertly crafted from Panzerholz, along with the same special paint and polish finish borrowed from our local Franconian violin makers. And if you're wondering about the name, the 'Jubilee' MC and MM phono cartridges have been created to mark Clearaudio's 40th anniversary, recognising four decades of dedication to 'loving music' – which always worth celebrating.



Charisma V2



Maestro V2



Virtuoso V2



Jubilee MM



Performer V2



Artist V2



concept V2

Images enlarged for viewing

Images enlarged for viewing

ready for LIVE

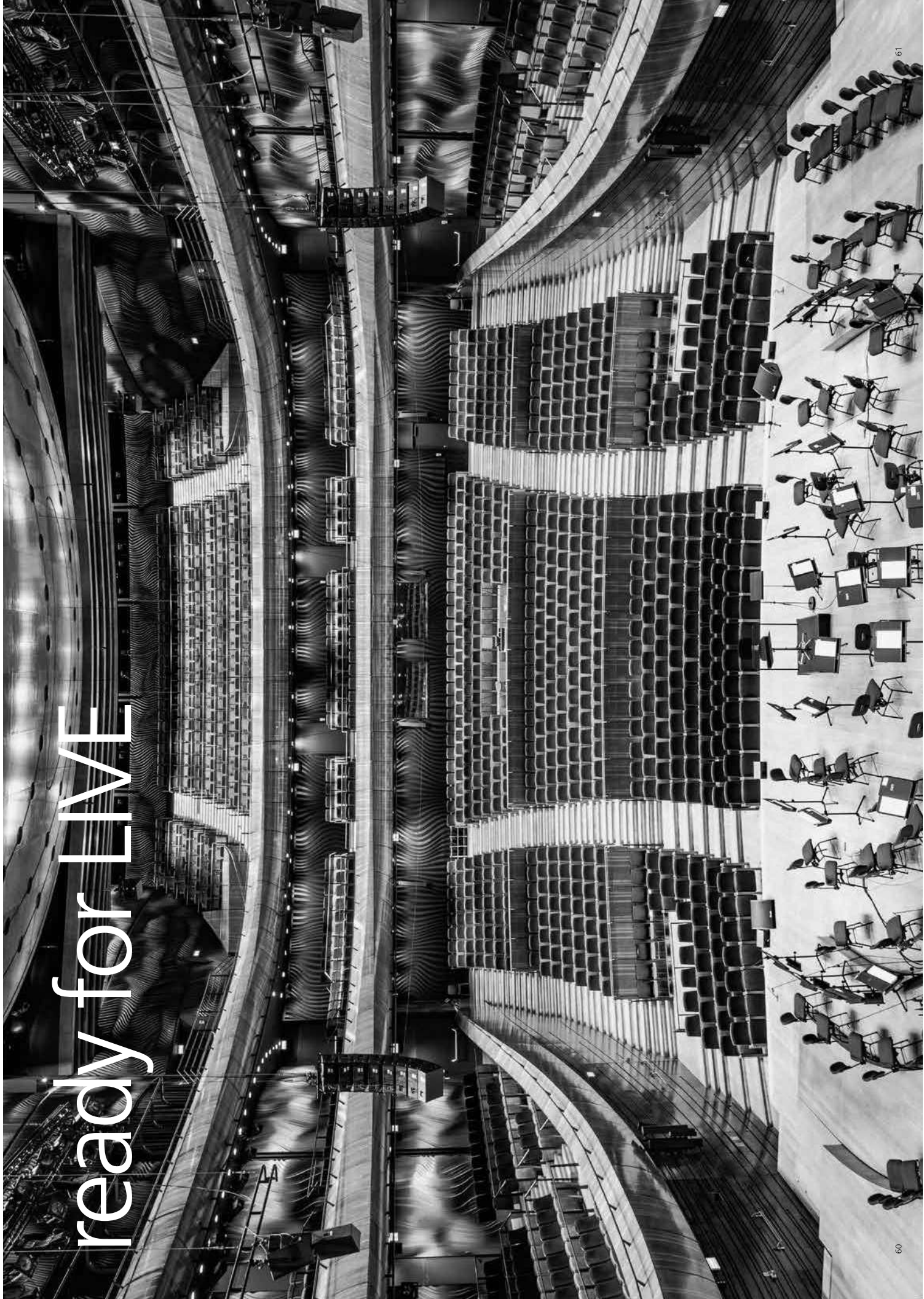

# Electronics

Being specialised in analogue music playback, it is our responsibility to promote continuous technological development to create improved standards that establish audiophile listening pleasure at its highest level. Perfection in manufacturing and measurement is reflected in a superior sound: The purest listening quality, and the reason we put our concentration on even the tiniest detail.

Without exception, our phono stages are constructed using carefully selected components of the highest material quality. At Clearaudio, to avoid any of the performance-limiting effects of mains electricity, all our power supplies are separated from the sensitive circuits. Clearaudio amplifiers are equipped with our own non-magnetic RCA plugs. Why? Because those who strive for excellence must be prepared to lead the way.





# statement phono - Top class for top demands

The statement phono is established at the absolute top - where the air is thin, but the sound quality reaches its maximum density. From the deepest bass to the highest treble, from the additional bass octave of an imperial grand piano to the piccolo flute of a full church organ and beyond, the statement phono presents sounds exactly as they are. It takes nothing away and does not add anything, but embodies the ideal of pure music reproduction. Silver mica capacitors ensure that the signals are handled without loss. Only the most noise-free resistors and capacitors, carefully selected, are worthy to take their place on the circuit boards of this monumental 34 kilogram phonostage.

This phonostage does not compromise. But it does allow you to connect and control the volume of all major sources via two phono inputs and two additional analogue inputs.

For power, an external battery power supply is used, so that interference from the mains electricity does not exist. The statement phono embodies the ultimate truth of listening, and with its switchable input resistors and freely adjustable equalisation curves, addresses the needs of discerning analogue fans that want to extract the best sound from their records. This sound laboratory in miniature is unique and unmatched in the analogue world.



statement phono,  
rear view



statement phono controls



statement phono remote control

# absolute phono - Full power from the source

Clearaudio's absolute phono is the world's first active headshell moving coil phono stage. A tiny circuit board installed in the tonearm amplifies the highly sensitive output signal from the cartridge at its source. Now the delicate signal only has to travel a few millimeters rather than along the usual 1-2 metres of internal and external arm wiring before being amplified to a more resilient level. This amplified signal then passes to the specially designed main RAA phonostage, along a signal path free of the usual relays and coupling capacitors, which again enables a more clean, pure and accurate sound. The signal is then equalized and fed to both unbalanced RCA and balanced XLR outputs, each with its own output driver to ensure the utmost fidelity. The result? The signal to noise ratio is improved by approximately ten decibels across the entire audio spectrum. The absolute phono is built without compromise, incorporating

an anti-resonance sandwich construction machined from solid blocks of aluminium and bullet proof wood. The sophisticated power supply, located in a separate chassis, maintains interference to a minimum. Hand-selected state-of-the-art non-magnetic Clearaudio silver glimmer capacitors positioned at key areas of the circuit further ensure excellent clarity and purity of sound. A single multi-function switch for 'On', 'Off' and 'Mute' modes ensures a sleek finish.

The absolute phono is suitable for all Clearaudio tonearms and is designed to work perfectly with any moving coil cartridge from any manufacturer. This is ensured due to the selected current amplification control which eliminates the need to set the correct load resistance and load capacitance. The optimum operating condition is always set automatically.



absolute phono,  
black / black

absolute phono,  
rear view

absolute phono headshell with  
Clearaudio cartridge  
(cartridge not included)



absolute phono,  
silver / wood

# absolute phono inside - A revolution and a revelation

The absolute phono inside is a development of the absolute phono, designed for those who prefer not to have their tonearms modified to incorporate the headshell-mounted first gain stage. The absolute phono inside uses the absolute phono's innovative circuit design including the current amplification first gain stage. However in the inside, this is incorporated within the phono's main body. Through careful fine tuning, Clearaudio have been able to deliver many of the improvements bought about by the absolute phono in a more conventional phono stage configuration. Both unbalanced RCA and balanced XLR inputs are provided for connection to any tonearm on the market. These feed the fully balanced current amplification first gain stage, avoiding any need to set cartridge loading and thereby ensuring a perfect synergistic match with any moving coil cartridge. This amplified signal then passes to the specially designed main

RIAA phono stage, along a signal path free of the usual relays and coupling capacitors, which again enables a more clean, pure and accurate sound. The signal is then equalized and fed to the balanced XLR outputs. The result? The signal to noise ratio is significantly enhanced, almost matching the headshell-mounted absolute phono's ten decibel improvement. The absolute phono inside is built without compromise, incorporating an anti-resonance sandwich construction machined from solid blocks of aluminium and bullet proof wood. The sophisticated power supply, located in a second, similar, matching, chassis, keeps mains interference to a minimum. Hand-selected state-of-the-art non-magnetic Clearaudio silver glimmer capacitors positioned at key areas of the circuit further ensure excellent clarity and purity of sound. Like the absolute phono, a single multi-function switch for 'On', 'Off' and 'Mute' modes ensures a sleek finish.



absolute phono inside,  
silver / wood

absolute phono inside,  
rear view



Detail of absolute phono inside



absolute phono inside multi-function  
button



absolute phono inside,  
rear view



absolute phono inside,  
black / black

# balance reference phono

The new balance reference phono was developed especially for the phono enthusiast, featuring completely independent phono inputs for connecting moving coil and moving magnet phono cartridges. It provides total freedom in selecting balanced (XLR) or single-ended (RCA) inputs and outputs with the total flexibility of adjusting the input impedance for most cartridges.

The sophisticated volume and input circuitry are accessible with the supplied remote control. The high-performance design provides 2 headphone connections. A dual-mono power supply housed in its own dedicated aluminium chassis assures the highest sound quality. The balance reference phono is truly a world-class phono stage for analog aficionados.



balance reference phono, silver



balance reference phono, black



balance reference phono, rear view

# balance V2

How do you balance simplicity with complexity?

Clearaudio's balance plus phono stage managed it with ease and now the new balance V2 advances its technologies while losing none of the equilibrium. On the one hand, its design remains elegantly unfussy and its operation effortlessly intuitive. And yet at the same time, the balance V2 offers an array of options to adjust and fine-tune its performance to your particular system and preferences.

The sleek casing is crafted from precision-milled aluminium, which is also available with an anodized black finish. As well as the usual RCA outputs, the balance V2 features balanced XLR outputs and a 6.3 plug headphone output. All RCA inputs and outputs are gold-plated for superior signal transmission.

Besides the manual volume control you can choose between mute and automatic mode by button. A simple switch allows you to choose between moving magnet and moving coil mode. From there, the balance V2 will automatically harmonize with almost any high-end phono cartridge without you needing to make any further adjustments.

High-precision RIAA equalization achieves an accuracy of within 0.1dB, while an optional subsonic filter attenuates any unwanted low frequency noise. A separate power supply in its own aluminium casing keeps any potential unwanted interference at bay.

With this small yet high-performance package, Clearaudio effectively balances audiophile-quality technology with a simplicity that can be enjoyed by any music enthusiast. Just take a seat and enjoy.



balance V2, silver



balance V2, black



balance V2, rear view

## basic V2

There's nothing basic about the basic V2 phono stage. Don't be fooled by its cool, minimalist design. Within that sleek aluminium casing (with silver or black anodized finish) lies an inner world of highly refined features. Its predecessor, the basic plus, was a multi award winner and with the V2 we've taken all of that coveted 'Plus' technology up a notch.

On the outside, we've kept it very simple. There's just one visible control, a single power switch on the upper surface that opens up a raft of possibilities. On the underside you can switch between

moving coil and moving magnet mode. From there, you can easily enjoy the basic V2 with almost any high-end phono cartridge without making any further adjustments or you can choose from a range of performance enhancing settings to fine-tune its parameters to your system and your heart's content. An optional subsonic filter attenuates any unwanted low frequency noise, while RIAA equalization accuracy is within 0.1 dB. All of which adds up to the basic V2 being the perfect all-rounder for both audiophiles and music lovers.



basic V2, rear view

## smart phono V2 smart phono headphone V2

A minimalist aluminium housing that contains one of the best sounding phono stages in its market. Up to 54 decibels gain at one kilohertz and an extremely linear frequency response deliver unprecedented quality at this price point. For MM and MC cartridges there are two separate circuit designs using SMD

technology, which are selected by a slide switch on the underside. A light 620 gram phono stage that seduced the worldwide audio press. The only thing that is 'entry level' about this product is its price.

The smart phono V2 is also available with headphone output.



Setting options on the bottom side

smart phono V2 / smart phono headphone V2, rear view

# nano phono V2 nano phono headphone V2

The nano phono V2 phono stage isn't ruffled by anything. External interferences are no longer an issue with this fine piece of engineering. Its meticulously selected SMD components are assembled by hand in Erlangen and tested several times. The reward of these efforts is a signal to noise ratio of up to 84 decibels.



Setting options on the bottom side



nano phono V2 / nano phono headphone V2, rear view

# smart power 24V

The smart power 24V is a battery-based DC power supply upgrade, designed to unleash more of the considerable potential of Clearaudio's high-performance Ovation, Innovation and Statement turntables. It partners intelligent circuit technology with long-lasting NiMH (nickel-metal hydride) rechargeable batteries to deliver 24 volt of pure, clean, fluctuation-free power.

The smart power 24V can be set to switch automatically from battery play mode into recharging mode if desired. Even when recharging, it continues to offer an improvement in sound quality as well as adding safety features such as protection against short circuits and overvoltage. Its elegant, low-key design includes a dimmable LCD display.



smart power 24V on Innovation Series Stand

smart power 24V, rear view

Display smart power 24V

## smart power 12V

The smart power 12V is a battery-based DC power supply upgrade designed for Clearaudio's concept series and Performance DC turntables. Like the smart power 24V, it provides clean power that is independent of the variability and inherent noise of the mains supply. With a minimal output impedance, it delivers a steady, stable voltage, allowing your concept or Performance DC turntable to maintain perfect speed stability. Again, like the 24V

version, the smart power 12V can be set to switch automatically from battery play mode into recharging mode and will continue to enhance your turntable's performance and protect it from short circuits and power surges, even while charging. When used with the concept active turntable, the smart power's (12V) benefits are multiplied, since both the turntable's motor and the on-board phono stage are fed with pure, clean DC power.



76

## Professional Power 24V

The Professional Power 24V is a high-quality transformer-based and stabilized 24 Volt DC power supply. It is designed to fill the gap between the standard power supply that comes with our turntables and our state-of-the-art, auto-charging smart power 24V battery supply.

The Professional Power 24V provides improved filtering over the standard power supply, which delivers a much cleaner power source. Cleaner power and increased 'headroom' for Clearaudio's Innovation and Ovation series turntables, thanks to a smoother

motor performance and extended reserves. The resulting improvements in sound quality are significant.

The unit's construction features professional-grade electronic components and a resonance-optimized transformer to ensure that no mechanical interference will be transferred through the housing. The attractive design and improved listening experience will ensure that the Professional Power 24V is a welcome addition to your home audio system.



77



77

# Record Cleaning Machines

Records are valuable documents and important cultural artefacts. They deserve sympathetic care to preserve their sound quality – which, to date, has still not been matched by any digital playback systems. For high-end audio fans, a record-cleaning machine is an essential piece of kit to ensure vivid sound quality without crackles and to preserve the long life of your records.



Record groove before cleaning



Record groove after cleaning



# double matrix professional SONIC - Deep record cleaning with sonic option

The cleaning of vinyl records is a key discipline in maintaining a high-quality record collection and Clearaudio's research and development team continue to strive for the perfect equipment for this job. The double matrix professional SONIC is our best solution yet.

The Sonic refers to a sonic option, in which sonic vibrations enable deep cleaning while being gentle and almost noise-free. Variable speed operation and static electricity removal as part of the cleaning process ensure perfect results.

Like a camera with dual automatic and manual functions, the double matrix professional SONIC offers the possibility of operating the whole cleaning process at the touch of a single button, as well as the ability to control each step in the process with a user-friendly operating panel.

The cleaning head and the automatic cleaning programs are optimized for 12" records of various thicknesses. Smaller records (7" and 10") can be cleaned with the manual cleaning mode without changing the cleaning head.

Another improvement is the removable microfibre carrier of the cleaning and vibrations pads, which enable effortless exchange of the microfibre stripes. An LED light indicates the cleaning fluid level in the internal tank and, as an additional precaution, the suction turbine features overheating protection.

Made from high-quality and heavy-duty materials, the double matrix professional SONIC is designed for continuous operation, so that record collectors and traders can clean complete record collections. And yet it is incredibly easy to use and maintain.



double matrix professional SONIC,  
black



Cleaning and vacuum unit



Innovative washing unit



Level indication LEDs



Antistatic unit



Comfortable control panel



Multifunction button  
with blue LED ring



double matrix professional SONIC,  
silver

# smart matrix SILENT - Clean and serene



A freshly-cleaned vinyl record has so much more to offer: More information, more details and better sound. Audio experts advocate cleaning not only your latest flea market finds but also your brand new LPs fresh from the press. Clearaudio's smart matrix SILENT record cleaning machine combines precise cleaning with oh-so-gentle handling of your precious vinyl collection. No more dust, dirt or chemical residues from pressing. And, as its name suggests, this 'vinyl whisperer' comes with an exceptionally quiet operating mode. What's more, in its new enhanced edition the smart matrix SILENT is smarter than ever, sporting a raft of intelligent upgrades.

The new multi-functional cleaning arm cleverly handles the cleaning fluid application as well as suction. In addition it is easily adjustable to any size of vinyl or shellac record to receive

the best cleaning result. For easy maintenance and transport, the cleaning arm can be removed without the need of any tool. The main components such as the motor, pump, cleaning fluid reservoir, and waste fluid tank are identical to the double matrix professional SONIC. Also, the selection functions and features are intuitive and effortless than ever, thanks to the new high-quality bush buttons which are already used in the top model. As the cleaning process starts by swinging the arm into place, there is no need for an power button.

The smart matrix SILENT is available in silver or black, and a matching universal clamp, designed to hold any size of vinyl or shellac record securely in place, is supplied, an matching dustcover is available separately.



smart matrix SILENT  
black

smart matrix SILENT  
with dustcover



smart matrix SILENT,  
silver



Suction device



smart matrix SILENT  
control panel

Further accessories on the subject  
of vinyl cleaning on page 94



# brehtaking

# Accessories

Each music lover is different and so we would never presume to dictate what an individual listener 'should' want to hear. There is no single perfect setup. On the contrary, 'perfection' to us means that every individual's 'sweet spot' can be enjoyed to its full potential. That's why we offer such a wide range of options in our accessories – to allow any and every variation of fine-tuning.

Every detail counts in the search for the ultimate listening experience. From level gauges to record clamps and stylus cleaners to test records, every last one of our accessories is developed to the absolute best of our knowledge. Every connector, every cable, every counterweight – each product is a challenge, an inspiration and a delight to conceive and create.



# Cables

Only those who work with the utmost meticulousness on the improvement of music playback know the extent to which power and signal cables influence the sound quality.

Since the early days of Clearaudio, our engineers have undertaken ongoing research aimed at steadily improving the combination of music playback components and perfect power sources. On the way to absolute perfection, the Clearaudio developer clearly analysed which factors are needed to create the perfect tonearm cables:

Absolute flexibility to allow any movement of the tonearm without interference. Cables and insulation meet the highest quality standards. The cable must be microphone-resistant on its

whole length and through ideal shielding any impairment of the energy transport is avoided.

The result is presented in a range of cable connections and special elements for clearly defined types of signals. Clearaudio has the optimum cable for every need, from phono signals of small amplitude up to the massive power supply that needs high power connectors of the most sophisticated design.

Our know-how guarantees perfect insulation of the signal conductors, 100 per cent phase consistency and perfect channel balance. This makes the perfect sound: Distortion-free, clear and natural.



# Connectors

## RCA plug

The non-magnetic direct gold plated beryllium copper of this RCA plug guarantees an undistorted signal flow, providing the perfect partner for all RCA phono sockets.



## Tonearm cable connector (DIN 5-pole)

A truly high-end 5-pin tonearm cable connector exquisitely manufactured from non-magnetic materials and finished with a pure gold plated surface. Precision sprung internal contacts ensure a perfect connection between tonearm and cable, maintaining the highest fidelity of the delicate phono signal.



## RCA socket

The non-magnetic beryllium copper body together with Clearaudio's special gold plating process ensure that this RCA phono socket offers supreme audiophile quality.



## Cartridge pins

The delicate low-level signals from a phono cartridge need precise and very secure connections. Differing diameters of cartridge pins are accommodated by the spring-loaded fit of this connector, ensuring that no vital information is lost.



# Innovation Series Stand

Clearaudio stands for excellent listening pleasure — and visual appeal. Therefore, we design our stands as highly functional home accessories for aesthetes: Elegant and timeless in their appearance and well constructed down to the smallest detail. Only the best materials such as solid aluminium and bullet proof wood are used to achieve the highest possible quality. Each platform is further enhanced with aluminium surface plates. Even your heaviest devices will rest comfortably. Very solid spikes decouple Clearaudio stands so effectively that they remain totally unaffected by resonance. Each stand can be designed to be flexible in the number of levels and the total height. And your listening experience will reach a new level.



Innovation Series Stand, black with Master Innovation



Innovation Series Stand, black

Innovation Series Stand, silver



Rack detail, black



Rack detail, silver

# Accessories

Headshells, alignment gauges, tonearm base, cleaning and perfect sound. We're honoured to help, and delighted to know maintenance. We've got it all covered. But it's up to you – that our lovingly-crafted products will end up in such expert music lover, audiophile, aficionado – to decide on the specific combination of instruments that will allow you to achieve 'your'



Professional Analogue toolkit



Smart stylus precise cartridge tracking force gauge



Weight Watcher touch digital cartridge tracking force gauge



High precision level gauge, stainless steel



Precision level gauge, mounted in a stainless steel ring



Mini Level Gauge



Precision level gauge, basic version



Clearaudio Break-In Testrecord



Clearaudio Trackability Testrecord



Real time 300Hz light source with Siroscope test record



Cartridge and tonearm EC alignment gauge



Multi Installation Gauge for radial tonearms (includes Siroscope and Speed Light 300Hz light source)



Magnifying glass

# Accessories



Carbon fibre brush, artistic



Pure Groove brush



Dust protector for turntable platter



Stylus cleaning brush

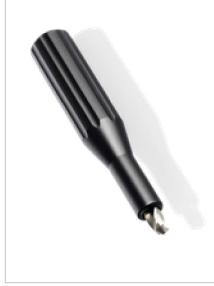

LP Drill



Dustcover, acrylic, different sizes available



Clear Contact, electronic contact cleaner



Diamond cleaner - Elbir of Sound



Professional Turntable Care Kit



Polish Paste



Bearing Oil



Professional record cleaning fluid, available in various sizes for vinyl or shellac



Perfect Points, silver, (also available in black)



Ceramic Magnetic Bearing (CMB)

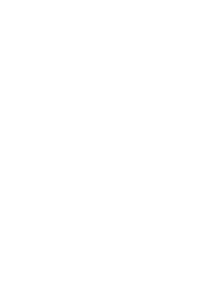

Headshell with SME-connection, including cartridge leads



Universal silicon belt, available in different lengths with 1 or 2mm diameter

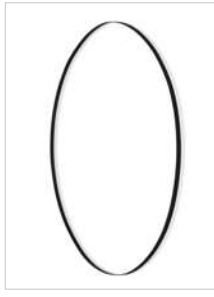

Calibrated flat belt available in different lengths



Headshell cable set (also available in copper)

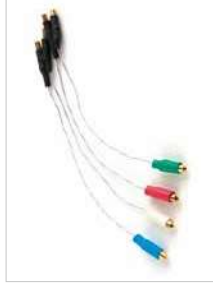

VTA-Lifter, perfect height adjustment for radial tonearms (also available in black)



Turboweight counterweight for radial tonearms



Armboard for radial tonearms (silver)



Armboard for radial tonearms (silver)



Armboard for radial tonearms (black)



Armboard for radial tonearms (black)



# Accessories



concept record clamp, 190g



Clever clamp, record clamp, 20g



Quadro clamp record clamp, stainless steel, 360g



Twister record clamp, 190g



Quadro clamp, record clamp, flat version, stainless steel, 242g



Single adapter, precision machined, stainless steel



Outer Limit with Locator



Clamp mat brown, Ø approx. 101mm



Clamp mat black, Ø approx. 101mm



Statement record clamp, ebony, 765g



Innovation record clamp black, 740g



Statement record clamp, natural wood, 765g



Innovation record clamp silver, 740g



Vinyl Harmonic turntable mat



Leather Mat black, Ø approx. 293mm, also available in brown



Felt mat



Vinyl Travel Bag



Record bag

# Company

Welcome to the circle of winners! Every Clearaudio product comes from a family with many winners. Awards from the global audiophile press as well as internationally acclaimed awards such as the Red Dot Award and the Design Award of Germany, grace many Clearaudio developments.

We see this as both recognition and further incentive for our continuing research to find the most perfect sound reproduction. These awards also validate our belief that the fine art of music demands mechanical masterpieces made with sophisticated craftsmanship and a genuine love of music. For more than 35 years we have been creating and manufacturing high-end solutions for people who share our love of music, with the aim of ensuring your ultimate listening experience: Audible, palpable and even clearly visible in our advanced designs.

The standards we set ourselves are high – in design, aesthetics, function, quality and service. Your audiophile needs are our constant inspiration for new, reliable components that reflect sound reality as closely as possible. Existing products are retested continuously and optimised in detail. Our prototypes run through sophisticated test phases in which all product characteristics and parameters are analysed and perfected. Only when we are absolutely confident of quality and performance are our products released to the market.

Our commitment to the exceptional performance of our products is reflected in generous warranty services.

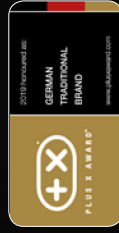

# Company



High specialised staff, the highest quality materials, skilful workmanship, uncompromisingly accurate design and ingenious production technology – all taking place in Etlangen, centre of science and location of the world-famous Friedrich-Alexander University. Our city shapes and influences our aspirations and expertise.

In close proximity to the Fraunhofer and Max Planck Institutes, our engineers and mechanics research future technology – for ever greater acoustic quality. Under the Clearaudio banner, highly trained perfectionists with innovative imaginations help to make audiophile visions come true.

To reach this aim, our technicians and engineers collaborate with a wide range of experts – including precision engineers, watchmakers, electronic engineers, physicists and industrial designers. The finest materials are then intelligently combined to produce impressive forms, parts and products that bear the unmistakable signature of Clearaudio. To preserve this signature for generations to come, we share our knowledge with ambitious young trainees. As a leading training company, we take social responsibility. With our headquarters in the Mittelwald nature reserve we are even pioneering ecological sustainability.

You deserve the best: Outstanding sound, flawless perfection. To achieve this maximum in performance and durability, Clearaudio invests a large amount of time. Analogue music playback is a demanding and specialised area of craftsmanship which requires

considerable patience in order to achieve maturity in development and production.

To maintain our commitment to quality, we produce most of our precision components in-house. This requires ongoing investment in production capabilities and provides independence from third party manufacturers – fundamental pillars of the Clearaudio philosophy, and the only way to ensure consistency, clear documentation, enduring quality and traceable results.

To reliably and precisely determine all measured data values, our engineers and technicians rely on leading technologies and methods. When standard measurements are insufficient to meet our needs, our in-house engineers develop our own measuring devices, working closely with external researchers to meet the high demands of Clearaudio performance.

This philosophy is the basis for stunning innovation and growing perfection.

To ensure the highest level of quality, we must be able to monitor every step of the manufacturing process in real time. This is why we rely on in-house craftsmanship. Only a tiny proportion of our components are externally sourced – all exclusively from certified and specialised suppliers, usually found as locally as possible. All such component parts must fulfill strict Clearaudio requirements. Each product line undergoes a number of test steps. During the development of materials, continuous performance tests ensure

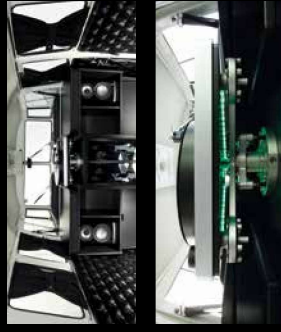

optimum results. Clearaudio products leave our factory only after a careful and protocolled module test. All of which means that product faults are extremely rare, but even so we retain all spare parts for up to 10 years after product launch – a unique service appreciated by our customers.

In accordance with worldwide distribution requirements, Clearaudio's products meet all international guidelines. We combine passion with responsibility.

Although our products are globally unique and distinctive, they adapt perfectly to the individual requirements of audiophile music lovers all around the world.

Through this sophisticated strategy we fulfil our goal to support the preservation of analogue music reproduction, the importance of which has experienced renewed growth in recent years. Worldwide enthusiasm for audiophile listening is once again on the rise.

Clearaudio delights in this development and will continue to drive it forward actively as a high-end audio pioneer.

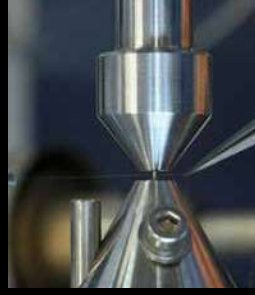

live on stage



# Technical Specifications

Turntables I

Model:	Statement V2	Master Innovation
Construction details:	Aluminium, stainless steel and bullet proof wood	<ul style="list-style-type: none"> <li>- Resonance-optimised chassis shape</li> <li>- Made of bullet proof wood and aluminium with precision CNC machined surface</li> <li>- All turntable feet are finely adjustable</li> <li>- Playback with three tonearms possible</li> </ul>
Speed options:	33 1/3, 45, 78rpm	33 1/3, 45, 78rpm
Drive unit:	<ul style="list-style-type: none"> <li>- High-torque 24V DC motor exclusively made for Clearaudio; Optical Speed Control (OSC) in real time through infrared sensor</li> <li>- Decoupled DC motor in chassis; resonance damping device; belt-driven</li> </ul>	<ul style="list-style-type: none"> <li>- High torque 24V DC motor exclusively made for Clearaudio; Optical Speed Control (OSC) in real time through infrared sensor</li> <li>- Decoupled DC motor in chassis; resonance damping device; belt-driven</li> </ul>
Bearing:	<ul style="list-style-type: none"> <li>- Magnetic decoupling of turntable and additional drive platter</li> <li>- Clearaudio patented ceramic magnetic bearing (CMB) in main platter / upper drive platter assembly</li> <li>- Inverted bearing in lower drive platter</li> </ul>	<ul style="list-style-type: none"> <li>- Magnetic decoupling of turntable and additional drive platter</li> <li>- Clearaudio patented ceramic magnetic bearing (CMB) in main platter / upper drive platter assembly</li> <li>- Inverted bearing in lower drive platter</li> </ul>
Platter:	98mm / 3.86 inch main platter, made out of synthetic material with high-density and excellent dimension stability. // precision CNC machined surface, solid stainless steel sub-platter, dynamically balanced	70mm / 2.75 inch main platter, made out of synthetic material with high-density and excellent dimension stability. // precision CNC machined surface, solid stainless steel sub-platter, dynamically balanced
Speed accuracy (measured):	≤ ± 0.03%	≤ ± 0.02%
Power consumption:	<ul style="list-style-type: none"> <li>Max. consumption: 19 watts</li> <li>Consumption in operation: 8 watts</li> <li>Standby mode: 0.0 watts</li> <li>Off mode: 0.0 watts</li> </ul>	<ul style="list-style-type: none"> <li>Max. consumption: 9.5 watts</li> <li>Consumption in operation: 4.1 watts</li> <li>Standby mode: 2.4 watts</li> <li>Off mode: 0.0 watts</li> </ul>
Total weight:	Approx. 350kg (without tonearm and power supply)	Approx. 60kg (without tonearm and power supply)
Dimensions (WD/H):	Approx. 27.17 x 24.41 x 52.17 inches (with T1 tonearm)	Approx. 18.11 x 19.09 x 15.59 inches (with tonearm base; without tonearm)
Dimensions (W/D/H):	Approx. 690 x 620 x 1325mm (with T1 tonearm)	Approx. 460 x 485 x 396mm (with tonearm base; without tonearm)
Manufacturer's warranty:	10 years*	5 years*

Turntables II

Model:	Innovation Basic	Ovation
Construction details:	<ul style="list-style-type: none"> <li>- Resonance-optimised chassis shape</li> <li>- Made of bullet proof wood and aluminium with precision CNC machined surface</li> <li>- All turntable feet are finely adjustable</li> <li>- Playback with two tonearms possible</li> </ul>	<ul style="list-style-type: none"> <li>- Resonance-optimised body, bullet proof wood chassis in sandwich construction embedded between two aluminium plates.</li> </ul>
Speed options:	33 1/3, 45, 78rpm	33 1/3, 45, 78rpm
Drive unit:	<ul style="list-style-type: none"> <li>- High torque 24V DC motor exclusively made for Clearaudio; Optical Speed Control (OSC) in real time through infrared sensor</li> <li>- Decoupled DC motor in chassis; resonance damping device; belt-drive</li> </ul>	<ul style="list-style-type: none"> <li>- High torque 24V DC motor exclusively made for Clearaudio; Optical Speed Control (OSC) in real time through infrared sensor</li> <li>- Decoupled DC motor in chassis; resonance damping device; flat belt-drive</li> </ul>
Bearing:	<ul style="list-style-type: none"> <li>- Clearaudio CMB ceramic magnetic bearing in main platter / upper drive platter assembly; inverted bearing in lower drive platter</li> <li>- 40mm / 1.57 inch main platter, made out of synthetic material with high-density and excellent dimension stability, precision CNC machined surface, solid stainless steel sub-platter, dynamically balanced</li> </ul>	<ul style="list-style-type: none"> <li>- Cut and polished ceramic shaft in a sintered bronze bushing</li> <li>- Clearaudio patented ceramic magnetic bearing (CMB)</li> <li>- Synthetic material, CNC-precision milled surface, 40mm thickness / 1.57 inch, Aluminium sub-platter</li> </ul>
Speed accuracy (measured):	≤ ± 0.08%	± 0.03%
Power consumption:	<ul style="list-style-type: none"> <li>Max. consumption: 9.3 watts</li> <li>Consumption in operation: 2.5 watts</li> <li>Standby mode: 2.5 watts</li> <li>Off mode: 0.0 watts</li> </ul>	<ul style="list-style-type: none"> <li>Max. consumption: 8.6 watts</li> <li>Consumption in operation: 2.5 watts</li> <li>Standby mode: 2.5 watts</li> <li>Off mode: 0.0 watts</li> </ul>
Total weight:	Approx. 8kg (without tonearm and power supply)	Approx. 13.5kg
Dimensions (WD/H):	Approx. 18.11 x 19.09 x 4.92 inches (with tonearm base; without tonearm)	Approx. 16.54 x 13.78 x 5.31 inches (without tonearm)
Dimensions (W/D/H):	Approx. 460 x 485 x 125mm (with tonearm base; without tonearm)	Approx. 420 x 350 x 135mm (without tonearm)
Manufacturer's warranty:	5 years*	5 years*

Turntables I

Model:	Innovation	Innovation Compact
Construction details:	<ul style="list-style-type: none"> <li>- Resonance-optimised chassis shape</li> <li>- Made of bullet proof wood and aluminium with precision CNC machined surface</li> <li>- All turntable feet are finely adjustable</li> <li>- Playback with two tonearms possible</li> </ul>	<ul style="list-style-type: none"> <li>- Resonance-optimised chassis shape</li> <li>- Made of bullet proof wood and aluminium with precision CNC machined surface</li> <li>- All turntable feet are finely adjustable</li> <li>- Playback with two tonearms possible</li> </ul>
Speed options:	33 1/3, 45, 78rpm	33 1/3, 45, 78rpm
Drive unit:	<ul style="list-style-type: none"> <li>- High torque 24V DC motor exclusively made for Clearaudio; Optical Speed Control (OSC) in real time through infrared sensor</li> <li>- Decoupled DC motor in chassis; resonance damping device; belt-drive</li> </ul>	<ul style="list-style-type: none"> <li>- High torque 24V DC motor exclusively made for Clearaudio; Optical Speed Control (OSC) in real time through infrared sensor</li> <li>- Decoupled DC motor in chassis; resonance damping device; belt-drive</li> </ul>
Bearing:	<ul style="list-style-type: none"> <li>- Clearaudio CMB ceramic magnetic bearing in main platter / upper drive platter assembly; inverted bearing in lower drive platter</li> <li>- 70mm / 2.75 inch main platter, made out of synthetic material with high-density and excellent dimension stability, precision CNC machined surface, solid stainless steel sub-platter, dynamically balanced</li> </ul>	<ul style="list-style-type: none"> <li>- Clearaudio CMB ceramic magnetic bearing in main platter / upper drive platter assembly; inverted bearing in lower drive platter</li> <li>- 70mm / 2.75 inch main platter, made out of synthetic material with high-density and excellent dimension stability, precision CNC machined surface, solid stainless steel sub-platter, dynamically balanced</li> </ul>
Speed accuracy (measured):	≤ ± 0.05%	≤ ± 0.08%
Power consumption:	<ul style="list-style-type: none"> <li>Max. consumption: 9.3 watts</li> <li>Consumption in operation: 2.5 watts</li> <li>Standby mode: 2.5 watts</li> <li>Off mode: 0.0 watts</li> </ul>	<ul style="list-style-type: none"> <li>Max. consumption: 9.3 watts</li> <li>Consumption in operation: 2.5 watts</li> <li>Standby mode: 2.5 watts</li> <li>Off mode: 0.0 watts</li> </ul>
Total weight:	Approx. 24kg (without tonearm and power supply)	Approx. 12kg (without tonearm and power supply)
Dimensions (WD/H):	Approx. 18.11 x 19.09 x 8.66 inches (with tonearm base; without tonearm)	Approx. 18.11 x 19.09 x 6.18 inches (with tonearm base; without tonearm)
Dimensions (W/D/H):	Approx. 460 x 485 x 220mm (with tonearm base; without tonearm)	Approx. 460 x 485 x 157mm (with tonearm base; without tonearm)
Manufacturer's warranty:	5 years*	5 years*

\*Provided the warranty card is fully completed and returned to Clearaudio or registered online within 2 weeks of purchase. More information about the power consumption of our products on [www.clearaudio.de](http://www.clearaudio.de)

Turntables I

Model:	Reference Jubilee	Performance DC
Construction details:	<ul style="list-style-type: none"> <li>- Resonance-optimised chassis shape</li> <li>- Made of laminated wood and aluminium with precision CNC machined surface</li> <li>- All turntable feet are finely adjustable</li> <li>- Optical Speed Control (OSC)</li> <li>- IMS – Innovative Motor Suspension (Suspension design of the motor using 18 O-rings)</li> </ul>	<ul style="list-style-type: none"> <li>- Resonance-optimised body, highly compressed wood chassis in sandwich construction embedded between two aluminium plates.</li> </ul>
Speed options:	33 1/3, 45, 78rpm	33 1/3, 45, 78rpm
Drive unit:	<ul style="list-style-type: none"> <li>- High torque 24V DC motor with belt drive</li> <li>- Fully automatic self-calibration of the speed by a push of a button</li> <li>- Hybrid engine control</li> <li>- A high resolution 12 bit digital-to-analog converter (DAC) generates a motor reference voltage, which is fed into the purely analog motor control, to ensure a high-precision reproduction of friction and temperature changes on the platter</li> <li>- The speed remains in the perfect range at all times</li> </ul>	<ul style="list-style-type: none"> <li>- Decoupled and resonance damped 12V DC motor, flat belt-drive and plug-in power supply unit designed for worldwide use with all networks and power frequencies.</li> </ul>
Bearing:	<ul style="list-style-type: none"> <li>- Clearaudio CMB ceramic magnetic bearing in main platter; inverted bearing in lower drive platter</li> <li>- 50mm / 1.97 inch main platter, made out of synthetic material with high-density and excellent dimension / 13mm / 0.59 inch stability, precision CNC machined surface, solid stainless steel sub-platter, dynamically balanced</li> </ul>	<ul style="list-style-type: none"> <li>- Cut and polished ceramic shaft in a sintered bronze bushing, Clearaudio ceramic magnetic bearing (CMB)</li> <li>- Synthetic material, surface CNC-precision milled, Surface CNC-precision milled, 1.1 inches / 40mm thickness</li> </ul>
Speed accuracy (measured):	≤ ± 0.05%	± 0.05%
Power consumption:	<ul style="list-style-type: none"> <li>Max. consumption: 5.0 watts</li> <li>Consumption in operation: 2.1 watts</li> <li>Off mode: 1.8 watts</li> </ul>	<ul style="list-style-type: none"> <li>Max. consumption: 3.3 watts</li> <li>Consumption in operation: 1.6 watts</li> <li>Standby mode: &lt; 0.5 watts</li> <li>Off mode: 0.0 watts</li> </ul>
Total weight:	Approx. 22kg (without tonearm and power supply)	Approx. 11.0kg
Dimensions (WD/H):	Approx. 19.49 x 13.50 x 7.09 inches (with tonearm base; without tonearm)	Approx. 16.54 x 12.99 x 4.92 inches (without tonearm)
Dimensions (W/D/H):	Approx. 495 x 343 x 180mm (with tonearm base; without tonearm)	Approx. 420 x 330 x 125mm (without tonearm)
Manufacturer's warranty:	5 years*	5 years*

\*Provided the warranty card is fully completed and returned to Clearaudio or registered online within 2 weeks of purchase. More information about the power consumption of our products on [www.clearaudio.de](http://www.clearaudio.de)

# Technical Specifications

## Turntables III

<b>Model:</b>	<b>concept active</b>
Construction details:	Resonance-optimised turntable, chassis comprises medium-density wood fibre (silver / black) or pressure-formed solid wood (wood / dark wood); upper layer incorporates high-tech sintered plastic compound.
Speed options:	33 1/3, 45, 78rpm
Drive unit:	Decoupled and resonance damped 12V DC motor, flat belt-drive and plug-in power supply unit designed for worldwide use with all networks and power frequencies.
Bearing:	Polished and tempered steel shaft in a sintered bronze housing, running on a teflon thrust-pad.
Platter:	30mm / 1.18 inch main platter, made out of synthetic material with high-density and excellent dimension / precision CNC machined surface aluminium sub-platter
Speed accuracy (measured):	± 0.05%
Power consumption:	Max. consumption: 17 watts Off mode: 0.0 watts
Amplification of the integrated phono preamp @ 0.5mV by 1kHz (MM / MC mode)	low 40dB; mid 45dB; high ~56dB (Gain setting)
THD of the integrated phono preamp:	< 1% @ 400mV output (MM / MC mode)
SIN of integrated phono preamp:	- 84dB (MM mode) / - 74dB (MC mode)
RIAA accuracy of integrated phono preamp:	± 1.5dB
Input load of integrated phono preamp:	47kΩ (MM mode) / 110kΩ (MC mode)
Max. output voltage of integrated phono preamp:	< 10V
Total weight:	Silver / black: Approx. 7.6kg / Wood / dark wood: approx. 8.0kg (incl. tonearm and cartridge)
Dimensions (W/D/H):	Approx. 16.54 x 13.78 x 4.92 inches (with tonearm)
Manufacturer's warranty:	Approx. 420 x 350 x 125mm (with tonearm) 2 years*



concept active

<b>Model:</b>	<b>concept</b>
Construction details:	Resonance-optimised turntable, chassis comprises medium-density wood fibre (silver / black) or pressure-formed solid wood (wood / dark wood); upper layer incorporates high-tech sintered plastic compound.
Speed options:	33 1/3, 45, 78rpm
Drive unit:	Decoupled and resonance damped 12V DC motor, flat belt-drive and plug-in power supply unit designed for worldwide use with all networks and power frequencies.
Bearing:	Polished and tempered steel spindle in a sintered bronze housing, running on a teflon thrust-pad.
Platter:	30mm / 1.18 inch main platter, made out of synthetic material with high-density and excellent dimension / precision CNC machined surface aluminium sub-platter
Speed accuracy (measured):	± 0.05%
Power consumption:	Max. consumption: 2.5 watts Consumption in operation: 0.5 watts Off mode: 0.0 watts
Total weight:	Approx. 7.5kg (incl. tonearm and cartridge)
Dimensions (W/D/H):	Approx. 16.54 x 13.78 x 4.92 inches (with tonearm)
Manufacturer's warranty:	Approx. 420 x 350 x 125mm (with tonearm) 2 years*



concept

\*Provided the warranty card is fully completed and returned to Clearaudio or registered online within 2 weeks of purchase. More information about the power consumption of our products on [www.clearaudio.de](http://www.clearaudio.de)

## Tangential tonearms

<b>Model:</b>	<b>TT1</b>	<b>TT1 MI</b>
Construction details:	Tangential tonearm Mechanical and passive drive through dry-running ball bearing in an calibrated polished glass tube	Tangential tonearm Mechanical and passive drive through dry-running ball bearing in an calibrated polished glass tube
Material:	Aluminium (black/silver), stainless steel, bullet proof wood (natural/black), glass	Aluminium (black/silver), stainless steel, bullet proof wood (natural/black), glass
Cartridge balance range:	5.5g - 15g	5.5g - 15g
Mounting style:	On request	On request
Wiring:	2m Super Sixstream terminated with RCA	2m Super Sixstream terminated with RCA
Weight:	Approx. 8.6kg, incl. armward	Approx. 8.2kg
Dimensions (W/D/H):	Approx. 21.26 x 8.27 x 8.27 inches	Approx. 21.26 x 8.27 x 7.68 inches
Dimensions (W/D/H):	Approx. 540 (incl. lift unit) x 210 x 210mm	Approx. 540 (incl. lift unit) x 210 x 195mm
Manufacturer's warranty:	10 years*	5 years*





<b>Model:</b>	<b>TT2</b>	<b>TT3</b>	<b>TT5</b>
Construction details:	Tangential tonearm Mechanical and passive drive through dry-running ball bearing in an calibrated polished glass tube	Tangential tonearm Mechanical and passive drive through dry-running ball bearing in an calibrated polished glass tube	Tangential tonearm Mechanical and passive drive through dry-running ball bearing in an calibrated polished glass tube
Material:	Aluminium (black/silver), stainless steel, glass	Aluminium (black/silver), stainless steel, glass	Aluminium (black/silver), stainless steel, glass
Cartridge balance range:	5.5g - 15g	5.5g - 15g	5.5g - 15g
Mounting style:	On request	On request	On request
Wiring:	2m Super Sixstream terminated with RCA	RCA connection / Super Sixstream terminated with RCA Direct Wire terminated with RCA (1.0 / 1.5m)	1.1m Super Sixstream terminated with RCA
Weight:	Approx. 2kg (without tonearm base); tonearm base only: approx. 245g	Approx. 690g (without tonearm base); tonearm base only: approx. 245g	Approx. 520g (without aluminium collar) Collar only: 65g
Dimensions (W/D/H):	Approx. 12 x 4.33 x 2.56 inches (without folding base; without height adjustment screw)	Approx. 10.83 x 3.74 x 1.77 inches (without folding base; without height adjustment screw)	Approx. 7.87 x 5.51 x 5.51 inches (incl. headshell)
Dimensions (W/D/H):	Approx. 300 x 110 x 65mm (without folding base; without height adjustment screw)	Approx. 275 x 95 x 45mm (without folding base; without height adjustment screw)	Approx. 200 x 140 x 140mm (incl. headshell)
Manufacturer's warranty:	5 Jahre*	5 years*	5 years*







\*Provided the warranty card is fully completed and returned to Clearaudio or registered online within 2 weeks of purchase. More information about the power consumption of our products on [www.clearaudio.de](http://www.clearaudio.de)

# Technical Specifications

## Radial tonearms

		
<b>Model:</b>	<b>Universal (9 inch)</b>	<b>Magnify (9 inch)</b>
<b>Construction details:</b>	Radial tonearm Using ultra low friction bearings Available in 9 and 12 inches	Radial tonearm Hybrid magnet-chall bearing tonearm
<b>Material:</b>	Aluminum (black/silver), stainless steel, carbon tonearm tube (black/silver)	Aluminum (silver), stainless steel, carbon tonearm tube (silver)
<b>Cartridge balance range:</b>	2.9g - 24.8g	4.7g - 22.0g
<b>Overhang:</b>	17.00mm	17.48mm
<b>Total length:</b>	345.00mm	330.00mm
<b>Effective length:</b>	239.00mm	239.48mm
<b>Mounting distance (tonearm pivot to spindle):</b>	222.00mm	222.00mm
<b>Offset angle:</b>	24.88°	25.45°
<b>Wiring:</b>	1.1m Clearaudio Super Sixstream terminated with RCA	1.1m Clearaudio Super Sixstream terminated with RCA
<b>Weight (incl. counterweight):</b>	Approx. 745g	Approx. 609g
<b>Manufacturer's warranty:</b>	5 years*	5 years*

		
<b>Model:</b>	<b>Tracer (9 inch)</b>	<b>Unify (9 inch)</b>
<b>Construction details:</b>	Radial tonearm Horizontal sapphire bearing and vertically ball bearing	Radial tonearm One point sapphire bearing Available in 9, 10, 12 and 14 inches
<b>Material:</b>	Aluminum (black/silver), stainless steel, carbon tonearm tube (black/silver)	Aluminum (black/silver), stainless steel, carbon tonearm tube (black/silver)
<b>Cartridge balance range:</b>	3.5g - 17.0g	2.5g - 17.0g
<b>Overhang:</b>	17.12mm	16.93mm
<b>Total length:</b>	320.00mm	305.00mm
<b>Effective length:</b>	239.12mm	238.93mm
<b>Mounting distance (tonearm pivot to spindle):</b>	222.00mm	222.00mm
<b>Offset angle:</b>	25.00°	23.80°
<b>Wiring:</b>	1.1m Super Sixstream terminated with RCA	1.1m Clearaudio Super Sixstream terminated with RCA
<b>Weight (incl. counterweight):</b>	Approx. 500g	Approx. 770g
<b>Manufacturer's warranty:</b>	3 years*	3 years*

			
<b>Model:</b>	<b>Satisfy Kardan (9 inch)</b>	<b>Clarify (9 inch)</b>	<b>concept / Verify (9 inch)</b>
<b>Construction details:</b>	Radial tonearm With magnetic antiskating	Radial tonearm With friction free magnetic bearing technology	Radial tonearm With friction free magnetic bearing technology
<b>Material:</b>	Aluminum (black/silver), stainless steel, tonearm tube made of aluminum (black/silver) or carbon (silver)	Aluminum (silver), stainless steel, carbon tonearm tube (silver)	Aluminum (silver), tonearm tube made of black aluminum (concept) or silver carbon (Verify)
<b>Cartridge balance range:</b>	2.5g - 17.0g	2.5g - 17.0g	2.5g - 17.0g
<b>Overhang:</b>	17.12mm	17.23mm	17.56mm
<b>Total length:</b>	305.00mm	330.00mm	305.00mm
<b>Effective length:</b>	239.12mm	239.25mm	239.56mm
<b>Mounting distance (tonearm pivot to spindle):</b>	222.00mm	222.00mm	222.00mm
<b>Offset angle:</b>	24.02°	25.45°	24.16°
<b>Wiring:</b>	1.1m Clearaudio Direct Wire terminated with RCA	1.1m Clearaudio Direct Wire terminated with RCA	1.1m Clearaudio Direct Wire terminated with RCA
<b>Weight (incl. counterweight):</b>	Satisfy Kardan Aluminum: approx. 490g Satisfy Kardan Carbon: approx. 480g	Approx. 410g	concept: approx. 450g Verify: approx. 440g
<b>Manufacturer's warranty:</b>	2 years*	2 years*	2 Jahre*

\*Provided the warranty card is fully completed and returned to Clearaudio or registered online within 2 weeks of purchase. More information about the power consumption of our products on [www.clearaudio.de](http://www.clearaudio.de)

## Electronics I

	
<b>Model:</b>	<b>statement phono</b>
<b>Mode:</b>	MM / MC switchable // Subsonic filter switchable
<b>Amplification:</b>	+ 34dB (MM mode) + 54dB (MC mode)
<b>Input load:</b>	47kΩ (MM mode) 25Ω - 10kΩ (MC mode)
<b>RIAA accuracy:</b>	± 0.05dB / 20 - 100kHz
<b>THD:</b>	5mV / 1kHz / +50dB: < 0.0035% 0.5mV / 1kHz / +70dB: < 0.0015%
<b>Signal to noise ratio:</b>	0.3mV / 1kHz / +70dB: -72dB / -80dB (A-weighted) + 25dB
<b>Headroom:</b>	> 12V
<b>Max. output voltage:</b>	75µs / 318µs / 3180µs, 2 passive filter
<b>RIAA:</b>	> 80dB (at 1kHz)
<b>Channel separation:</b>	10Q
<b>Output impedance:</b>	Phono 1: balanced XLR (rear) Phono 2: unbalanced RCA (rear) Line 1: balanced XLR (rear) Line 2: unbalanced RCA (rear) AUX: Jack 3.5mm (front)
<b>Inputs:</b>	
<b>Outputs:</b>	unbalanced (RCA) balanced (XLR) headphone output (jack: 6.3mm) Max. consumption: 200 watts In operation: 50 - 100 watts Standby mode: < 0.5 watts Off mode: 0.0 watts Fully symmetrical line and Accu - power supply 2 x 2 x 22V / 1A 2 x 18V / 3.2Ah Approx. 12kg Approx. 22kg Approx. 17.13 x 13.78 x 3.94 inches Approx. 4.35 x 350 x 100mm Approx. 17.13 x 13.78 x 3.94 inches Approx. 435 x 350 x 100mm 5 years*

		
<b>Model:</b>	<b>absolute phono (im Headshell)</b>	<b>absolute phono inside</b>
<b>Mode:</b>	MC mode	MC mode
<b>Amplification:</b>	60dB	60dB
<b>Input load:</b>	500kΩ	250kΩ
<b>THD:</b>	< 0.001%	< 0.001%
<b>Signal to noise ratio:</b>	90dB (A-weighted)	90dB (A-weighted)
<b>Headroom:</b>	+ 23dB	+ 23dB
<b>RIAA:</b>	RIAA standard, deviation less than 0,1dB	RIAA standard, deviation less than 0,1dB
<b>Channel separation:</b>	100dB	100dB
<b>Output impedance:</b>	64Ω (balanced XLR) 32Ω (unbalanced RCA)	64Ω (balanced XLR) 32Ω (unbalanced RCA)
<b>Inputs:</b>	D-Sub	2 (balanced XLR / unbalanced RCA)
<b>Outputs:</b>	unbalanced (RCA) balanced (XLR)	unbalanced (RCA) balanced (XLR)
<b>Power consumption:</b>	Consumption in operation: 3.2 watts Off mode: 0.0 watts	Consumption in operation: 6.5 watts Off mode: 0.0 watts
<b>Power supply:</b>	Switching power supply Input: 100 - 265V AC / 50 - 60Hz	Switching power supply Input: 100 - 265V AC / 50 - 60Hz
<b>Total weight preamplifier:</b>	Approx. 3.25kg	Approx. 3.25kg
<b>Total weight power supply:</b>	Approx. 3.20kg	Approx. 3.20kg
<b>Dimensions preamplifier (W/D/H):</b>	Approx. 9.45 x 6.30 x 2.56 inches	Approx. 9.45 x 6.30 x 2.56 inches
<b>Dimensions preamplifier (W/D/H):</b>	Approx. 240 x 160 x 65mm	Approx. 240 x 160 x 65mm
<b>Dimensions power supply (W/D/H):</b>	Approx. 9.45 x 6.30 x 2.56 inches	Approx. 9.45 x 6.30 x 2.56 inches
<b>Dimensions power supply (W/D/H):</b>	Approx. 240 x 160 x 65mm	Approx. 240 x 160 x 65mm
<b>Manufacturer's warranty:</b>	5 years*	5 years*

\*Provided the warranty card is fully completed and returned to Clearaudio or registered online within 2 weeks of purchase. More information about the power consumption of our products on [www.clearaudio.de](http://www.clearaudio.de)

# Technical Specifications

## Electronics II

balance reference phono	
<b>Model:</b> Mode:	MM / MC switchable (at bottom) // Stereo / Mono switchable
<b>Amplification:</b>	+ 46dB (MM mode) + 66dB (MC mode)
<b>Input load:</b>	50kΩ / 50pF (MM mode and MC mode) +150pF, +270pF, +400pF (MM mode) 10kΩ, 5kΩ, 1000Ω, 500Ω, 100Ω, 50Ω (MC mode)
<b>RIAA accuracy:</b>	± 0.1dB @ 20Hz - 100kHz
<b>THD:</b>	< 0.001% (IEC A)
<b>Signal to noise ratio:</b>	-89dB @ 5mV / MM mode (IEC A) -79dB @ 500uV / MC mode (IEC A)
<b>Headroom:</b>	> + 21dB @ 1kHz
<b>Max. output voltage:</b>	> 12V
<b>RIAA:</b>	75us / 318us / 3180us, 2 passive filter
<b>Channel separation:</b>	> 95dB @ 1kHz (IEC A)
<b>Output impedance:</b>	150Ω (balanced XLR) 75Ω (unbalanced RCA)



<b>Inputs:</b>	unbalanced (RCA) balanced (XLR)
<b>Outputs:</b>	unbalanced (RCA) balanced (XLR) headphone output (2x Jack: 6.3mm)
<b>Power consumption:</b>	Max. consumption: 12 watts Standby mode: < 0.5 watts Off mode: 0.0 watts
<b>Power supply:</b>	2x ± 18V DC (external power supply) 2x ± 21V DC, 1.4m cable length
<b>Total weight preamplifier:</b>	Approx. 2.9kg
<b>Total weight power supply:</b>	Approx. 2.9kg
<b>Dimensions preamplifier (W/D/H):</b>	Approx. 9.45 x 5.71 x 3.07 inches (6.22 inches depth with RCA)
<b>Dimensions preamplifier (W/D/H):</b>	Approx. 240 x 145 x 78mm (158mm depth with RCA)
<b>Dimensions power supply (W/D/H):</b>	Approx. 9.45 x 5.71 x 3.07 inches
<b>Dimensions power supply (W/D/H):</b>	Approx. 240 x 145 x 78mm
<b>Manufacturer's warranty:</b>	3 years*



<b>Model:</b> Mode:	MM / MC switchable (at bottom) // Subsonic filter switchable (at bottom)
<b>Amplification:</b>	+ 46dB (MM mode) + 66dB (MC mode)
<b>Input load:</b>	47kΩ / 270pF (MM mode) 500Ω / 270pF (MC mode)
<b>RIAA accuracy:</b>	± 0.1dB
<b>THD:</b>	< 0.001% (IEC A) -78dB (MM mode) -79dB (MC mode)
<b>Signal to noise ratio:</b>	> 12V (at 1kHz) + 23dB
<b>Headroom:</b>	> 12V (at 1kHz)
<b>RIAA:</b>	75us / 318us / 3180us, 2 passive filter
<b>Channel separation:</b>	> 92dB (at 1kHz)
<b>Output impedance:</b>	150Ω (balanced XLR) 75Ω (unbalanced RCA)
<b>Inputs:</b>	unbalanced (RCA) balanced (XLR)
<b>Outputs:</b>	unbalanced (RCA) balanced (XLR) headphone output (Jack 6.3mm)
<b>Power consumption:</b>	Max. consumption: 6.6 watts Standby mode: < 0.3 watts Off mode: 0.0 watts
<b>Power supply:</b>	± 18V DC (± 21V DC external power supply; 1.4m cable length)
<b>Total weight preamplifier:</b>	Approx. 2.3kg
<b>Total weight power supply:</b>	Approx. 1.4kg
<b>Dimensions preamplifier (W/D/H):</b>	Approx. 9.44 x 5.71 x 6.22 with RCA x 2.44 inches
<b>Dimensions preamplifier (W/D/H):</b>	Approx. 240 x 145 (158 with RCA) x 62mm
<b>Dimensions power supply (W/D/H):</b>	Approx. 240 x 145 x 62mm
<b>Dimensions power supply (W/D/H):</b>	Approx. 9.44 x 5.71 x 2.44 inches
<b>Manufacturer's warranty:</b>	3 years*

\*Provided the warranty card is fully completed and returned to Clearaudio or registered online within 2 weeks of purchase. More information about the power consumption of our products on [www.clearaudio.de](http://www.clearaudio.de)

## Electronics III

<b>Model:</b> Mode:	MM / MC switchable by jumpers (at bottom) // Subsonic filter switchable by jumpers (at bottom)
<b>Amplification:</b>	34dB (MM mode) 54dB (MC mode)
<b>Input load:</b>	50kΩ, 100kΩ, 500Ω, 1kΩ 5kΩ / 150pF, 250pF, 400pF (MC mode) 47kΩ / 150pF, 250pF, 400pF (MM mode)
<b>RIAA accuracy:</b>	± 0.3dB @ 10Hz - 100kHz
<b>THD:</b>	< 0.004% MC (* A @ 1kHz / -1dB @ MAX)
<b>Signal to noise ratio:</b>	85dB (A) (MM mode) 72dB (A) (MC mode)
<b>Headroom:</b>	18dB / MC (Gain Control on MAX)
<b>Max. output voltage:</b>	10V eff. (1kHz)
<b>RIAA:</b>	delay time: 75us / 318us / 3180us
<b>Channel separation:</b>	> 90dB @ 1kHz
<b>Output impedance:</b>	75Ω
<b>Inputs:</b>	unbalanced (RCA)
<b>Outputs:</b>	unbalanced (RCA) optional headphones output (Jack: 3.5mm)
<b>Power consumption:</b>	Max. consumption: 2.7 watts Consumption in operation: 2.7 watts Off mode: 0.0 watts
<b>Power supply:</b>	± 18V DC / 300mA (external power supply)
<b>Total weight:</b>	Approx. 620g (Preamp and power supply)
<b>Dimensions (W/D/H):</b>	Approx. 3.74 x 4.92 x 1.34 inches
<b>Dimensions (W/D/H):</b>	Approx. 95 x 125 x 34mm
<b>Manufacturer's warranty:</b>	3 years*



<b>Model:</b> Mode:	MM / MC switchable by jumpers (at bottom) // Subsonic filter switchable by jumpers (at bottom)
<b>Amplification:</b>	34dB (MM mode) 54dB (MC mode)
<b>Input load:</b>	50kΩ, 100kΩ, 500Ω, 1kΩ 5kΩ / 150pF, 250pF, 400pF (MC mode) 47kΩ / 150pF, 250pF, 400pF (MM mode)
<b>RIAA accuracy:</b>	± 0.3dB @ 10Hz - 100kHz
<b>THD:</b>	< 0.004% MC (* A @ 1kHz / -1dB @ MAX)
<b>Signal to noise ratio:</b>	85dB (A) (MM mode) 72dB (A) (MC mode)
<b>Headroom:</b>	18dB / MC (Gain Control on MAX)
<b>Max. output voltage:</b>	10V eff. (1kHz)
<b>RIAA:</b>	delay time: 75us / 318us / 3180us
<b>Channel separation:</b>	> 90dB @ 1kHz
<b>Output impedance:</b>	75Ω
<b>Inputs:</b>	unbalanced (RCA)
<b>Outputs:</b>	unbalanced (RCA) optional headphones output (Jack: 3.5mm)
<b>Power consumption:</b>	Max. consumption: 2.7 watts Consumption in operation: 2.7 watts Off mode: 0.0 watts
<b>Power supply:</b>	± 18V DC / 300mA (external power supply)
<b>Total weight:</b>	Approx. 620g (Preamp and power supply)
<b>Dimensions (W/D/H):</b>	Approx. 3.74 x 4.92 x 1.34 inches
<b>Dimensions (W/D/H):</b>	Approx. 95 x 125 x 34mm
<b>Manufacturer's warranty:</b>	3 years*



<b>Model:</b> Mode:	MM / MC switchable by jumpers (at bottom) // Subsonic filter switchable by jumpers (at bottom)
<b>Amplification:</b>	34dB (MM mode) 54dB (MC mode)
<b>Input load:</b>	47kΩ / 270pF / MM mode User MC mode
<b>RIAA accuracy:</b>	± 0.4dB @ 20Hz - 50kHz
<b>THD:</b>	< 0.04%
<b>Signal to noise ratio:</b>	81dB (A) (MM mode) 70dB (A) (MC mode)
<b>Headroom:</b>	18dB / MC
<b>Max. output voltage:</b>	10V eff. (1 kHz)
<b>RIAA:</b>	Nach RIAA Zeitkonst.: 75us / 318us / 3180us
<b>Channel separation:</b>	> 80dB @ 1kHz
<b>Output impedance:</b>	75Ω
<b>Inputs:</b>	unbalanced (RCA)
<b>Outputs:</b>	unbalanced (RCA) optional headphone output (Jack: 3.5mm)
<b>Power consumption:</b>	Max. consumption: 2.3 Watt In operation: 2.3 Watt Standby mode: < 0.3 Watt Off mode: 0.0 Watt
<b>Power supply:</b>	± 18V DC / 300mA (external power supply)
<b>Total weight:</b>	Approx. 500g (Preamp and power supply)
<b>Dimensions (W/D/H):</b>	Approx. 3.35 x 4.17 x 0.98 inches
<b>Dimensions (W/D/H):</b>	Approx. 85 x 106 x 25mm
<b>Manufacturer's warranty:</b>	3 years*



<b>Model:</b> Battery:	smart power 24V NiMH Battery with 5000mAh	smart power 12V NiMH Battery 12V 5000mAh	Professional Power 24V -
<b>Power supply:</b>	100 - 240V AC, 50 - 60Hz, max. 1.6A	100 - 240V AC, 50 - 60Hz, max. 1.6A	110V AC 60Hz, max. 200mA (time delay fuse) 240V AC, 50Hz, max. 200mA (time delay fuse)
<b>Output:</b>	24V DC, max. 1.6A, fused (time delay fuse)	12V DC, max. 1.6A, fused (time delay fuse)	24V, max. 500mA; fused (time delay fuse)
<b>Power consumption:</b>	Operation mode: 6.5 - 33 watts (depending on the charge cycle) Off mode: 0 watts (turned off at rear panel)	Operation mode: 6.5 - 33 watts (depending on the charge cycle) Off mode: 0 watts (turned off at rear panel)	In operation: 38.3rpm > 3.0 watts 45rpm > 3.1 watts 78rpm > 3.3 watts (switched on at the rear „I“) Off mode: 0.0 watts (turned off at rear panel "0")
<b>Total weight:</b>	Approx. 5.7kg	Approx. 2.2kg	Approx. 1.10kg
<b>Dimensions (W/D/H):</b>	Approx. 8.27 x 12.00 x 4.92 inches	Approx. 4.33 x 13.78 x 1.81 inches	Approx. 3.62 x 5.71 x 3.70 inches
<b>Dimensions (W/D/H):</b>	Approx. 210 x 305 x 125mm	Approx. 110 x 350 x 46mm	Approx. 92 x 145 x 94mm
<b>Manufacturer's warranty:</b>	3 years* (except batteries)	2 years* (except batteries)	2 years*

\*Provided the warranty card is fully completed and returned to Clearaudio or registered online within 2 weeks of purchase. More information about the power consumption of our products on [www.clearaudio.de](http://www.clearaudio.de)



# Technical Specifications

## Cartridges MC

Model:	Goldfinger Statement	Titanium V2	da Vind V2	Jubilee MC	Stradivari V2
Total mass:	~ 15.0g (± 2g)	10.0g	6.8g	7.5g	7.0g
Frequency response:	20Hz - 20kHz	20Hz - 20kHz	20Hz - 20kHz	20Hz - 20kHz	20Hz - 20kHz
Output voltage (at 5cm/sec):	0.5 - 0.6mV	0.5mV	0.5mV	0.5mV	0.5mV
Channel separation:	> 30dB	> 30dB	25 - 30dB	> 32dB	25 - 30dB
Channel balance:	< 0.2dB	< 0.5dB	< 0.5dB	< 0.5dB	< 0.5dB
Tracking ability:	90µm	90µm	80µm	80µm	80µm
Recommended tracking force:	2.8g (± 0.2g)	2.8g (± 0.2g)	2.8g (± 0.2g)	2.8g (± 0.2g)	2.8g (± 0.2g)
Cartridge impedance:	50Ω	50Ω	50Ω	50Ω	50Ω
Cantilever / stylus shape:	Boron / Clearaudio Prime Line	Boron / Clearaudio Prime Line	Boron / Clearaudio Prime Line	Boron / Clearaudio Prime Line	Boron / Clearaudio Prime Line
Compliance:	15µm/N	15µm/N	15µm/N	15µm/N	15µm/N
Coil assembly:	Absolutely symmetrical design	Absolutely symmetrical design	Absolutely symmetrical design	Absolutely symmetrical design	Absolutely symmetrical design
Coil material:	24 carat gold	24 carat gold	24 carat gold	24 carat gold	24 carat gold
Cartridge body:	14 carat gold	Titanium	Aluminium with 30 micron ceramic coating	Bullet proof wood	Ebony wood
Manufacturer's warranty:	2 years*	2 years*	2 years*	2 years*	2 years*

## Cartridges MM

Model:	Charisma V2	Maiestro V2	Virtuoso V2	Jubilee MM
Total mass:	9.0g (± 1g)	8.4g (± 0.4g)	8.4g (± 0.4g)	8.9g (± 0.4g)
Frequency response:	20Hz - 20kHz	20Hz - 20kHz	20Hz - 20kHz	20Hz - 20kHz
Output voltage (1kHz, 5cm/s):	~ 3.6mV	~ 3.6mV	~ 3.6mV	~ 3.6mV
Channel separation (1kHz):	30dB	25dB	26dB	26dB
Channel balance (1kHz):	0.2dB	0.3dB	0.4dB	0.4dB
Tracking ability:	90µm	80µm	80µm	90µm
Recommended tracking force:	2.4g (± 0.3g)	2.2g (± 0.3g)	2.2g (± 0.3g)	2.2g (± 0.3g)
Coil impedance (1kHz):	0.66kΩ	0.66kΩ	0.66kΩ	0.66kΩ
Coil inductance:	400mH	400mH	400mH	400mH
Load resistance:	47kΩ	47kΩ	47kΩ	47kΩ
Load capacitance:	100pF	100pF	100pF	100pF
Cantilever / stylus shape:	Boron / Clearaudio Prime Line	Boron / Shibata	Aluminium / elliptical	Aluminium / elliptical
Compliance:	17µm/N	16µm/N	15µm/N	15µm/N
Cartridge body:	Ebony wood with German Silver inlay	Ebony wood	Ebony wood	Bullet proof wood
Manufacturer's warranty:	2 years*	2 years*	2 years*	2 years*

Model:	Concerto V2	Talisman V2 Gold	essence mc	concept mc
Total mass:	7.0g	10.6 - 11.2g	8.0g	8.0g
Frequency response:	20Hz - 20kHz	20Hz - 20kHz	20Hz - 20kHz	20Hz - 20kHz
Output voltage (at 5cm/sec):	0.5mV	0.5mV	0.4mV	0.4mV
Channel separation:	25 - 30dB	25 - 30dB	> 30dB	> 28dB
Channel balance:	< 0.5dB	< 0.5dB	< 0.3dB	< 0.5dB
Tracking ability:	80µm	80µm	80µm	80µm
Recommended tracking force:	2.8g (± 0.2g)	2.8g (± 0.2g)	2.2g (± 0.2g)	2.2g (± 0.2g)
Cartridge impedance:	50Ω	50Ω	11Ω	11Ω
Cantilever / stylus shape:	Boron / Clearaudio Prime Line	Boron / Clearaudio Prime Line	Boron / Micro Line	Boron / Micro Line
Compliance:	15µm/N	15µm/N	9µm/N	9µm/N
Coil assembly:	Absolutely symmetrical design	Absolutely symmetrical design	OF - copper	OF - copper
Coil material:	24 carat gold	24 carat gold	Aluminium-magnesium alloy with ceramic surface layer	Aluminium-magnesium alloy with ceramic surface layer
Cartridge body:	Satine wood	Hand polished ebony wood body	Aluminium-magnesium alloy with ceramic surface layer	Aluminium-magnesium alloy with ceramic surface layer
Manufacturer's warranty:	2 years*	2 years*	2 years*	2 years*



Model:	Artist V2	Performer V2	concept V2
Total mass:	8.4g (± 0.4g)	8.4g (± 0.4g)	8.6g (± 0.2g)
Frequency response:	20Hz - 20kHz	20Hz - 20kHz	20Hz - 20kHz
Output voltage (1kHz, 5cm/s):	~ 3.6mV	~ 3.3mV	~ 3.3mV
Channel separation (1kHz):	24dB	20dB	20dB
Channel balance (1kHz):	0.6dB	1.5dB	2dB
Tracking ability:	80µm	80µm	80µm
Recommended tracking force:	2.2g (± 0.3g)	2.2g (± 0.3g)	2.2g (± 0.3g)
Coil impedance (1kHz):	0.66kΩ	0.66kΩ	0.66kΩ
Coil inductance:	400mH	400mH	400mH
Load resistance:	47kΩ	47kΩ	47kΩ
Load capacitance:	100pF	100pF	100pF
Cantilever / stylus shape:	Aluminium / elliptical	Aluminium / elliptical	Aluminium / elliptical
Compliance:	15µm/N	15µm/N	15µm/N
Cartridge body:	Ebony wood	Ebony wood	Aluminium
Manufacturer's warranty:	2 years*	2 years*	2 years*

\*Provided the warranty card is fully completed and returned to Clearaudio or registered online within 2 weeks of purchase. More information about the power consumption of our products on [www.clearaudio.de](http://www.clearaudio.de)

\*Provided the warranty card is fully completed and returned to Clearaudio or registered online within 2 weeks of purchase. More information about the power consumption of our products on [www.clearaudio.de](http://www.clearaudio.de)

# Technical Specifications

## Record cleaning machines

	
<p><b>Model:</b> double matrix professional SONIC</p> <p><b>Main features:</b></p> <ul style="list-style-type: none"> <li>- Left and right turning</li> <li>- Cleaning of both sides</li> <li>- Vacuum engine with overheat sensor</li> <li>- Integrated antistatic brushes for discharge of static charge</li> <li>- Automatic fluid application</li> <li>- Sonic option – gentle and high efficient cleaning through vibration</li> <li>- Automatic cleaning process with only one button</li> <li>- Optional manual control of each cleaning step</li> </ul>	<p><b>Model:</b> smart matrix SILENT</p> <ul style="list-style-type: none"> <li>- Bidirectional rotation of the platter</li> <li>- Integrated fluid application</li> <li>- Very rigid chassis</li> <li>- Included record clamp and single adapter</li> <li>- Multifunctional cleaning arm for LPs, EPs and singles</li> <li>- Easy controls</li> </ul>
<p><b>Power consumption:</b></p> <p>Max. consumption: Approx. 450 watts Off mode: 0 watts (by switching off at the rear of the machine)</p>	<p>Max. consumption: Approx. 300 watts Off mode: 0 watts (by switching off at the rear of the machine)</p>
<p><b>Weight:</b></p> <p>Approx. 16kg</p>	<p>Approx. 10,6kg</p>
<p><b>Dimensions (W/D/H):</b></p> <p>Approx. 16,14 x 15,16 x 10,87 inches (incl. record clamp) Approx. 16,14 x 15,16 x 11,42 inches (with acrylic dustcover)</p>	<p>Approx. 13,58 x 13,58 x 9,25 inches (with record clamp) Approx. 13,58 x 13,58 x 9,84 inches (with dustcover)</p>
<p><b>Dimensions (W/D/H):</b></p> <p>Approx. 410 x 385 x 276mm (incl. record clamp) Approx. 410 x 385 x 290mm (with acrylic dustcover)</p>	<p>Approx. 345 x 345 x 225mm (with record clamp) Approx. 345 x 345 x 230mm (with dustcover)</p>
<p><b>Manufacturer's warranty:</b></p> <p>3 years*</p>	<p>3 years*</p>

\*Provided the warranty card is fully completed and returned to Clearaudio or registered online within 2 weeks of purchase. More information about the power consumption of our products on [www.clearaudio.de](http://www.clearaudio.de)

## Accessories

	<p><b>Model:</b> Innovation Series Stand</p> <p><b>Construction details:</b> Made of bullet proof wood and aluminium with precision CNC machined surface. Caps made of stainless steel</p> <p><b>Total weight:</b> Approx. 35kg</p>
---	---

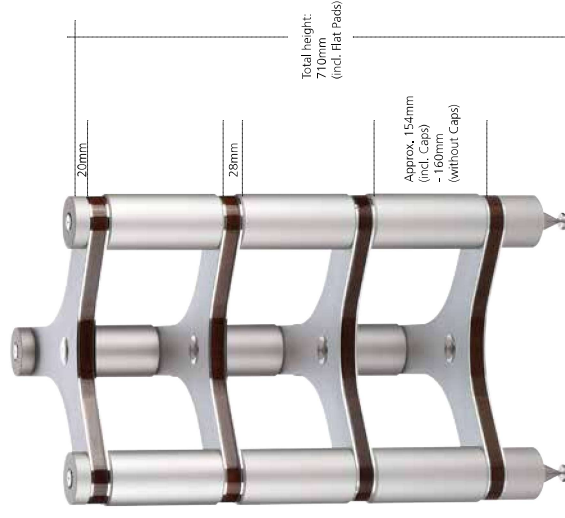

\*Provided the warranty card is fully completed and returned to Clearaudio or registered online within 2 weeks of purchase. More information about the power consumption of our products on [www.clearaudio.de](http://www.clearaudio.de)



## Find out more about Clearaudio products

Please see our English language website at:  
[www.clearaudio.de](http://www.clearaudio.de) for full details of all Clearaudio products or you can contact  
your local Clearaudio distributor or dealer  
(listings of international distributors/dealers are given on our website).

## Acknowledgements

Concept, artwork and production by:  
AUFSESS Kommunikation GmbH, Nuremberg, Germany [www.aufsess.com](http://www.aufsess.com)

Photo credits:

- Cover, 60/61 - Radek Grzybowski, unsplash
- 5: Thomas Riese
- 6/7: Arindam Mahanta, unsplash
- 20/21, 36/37, 50/51, 84/85, Back cover: Lucja Romanowska
- 102/103: Suteishi, getty images
- Product photos: Christian Schleupner

## Disclaimer

Technical specifications are subject to change or improvement without prior notice.  
Clearaudio accepts no liability for any misprints.

Product availability as long as stock lasts.

© Clearaudio Electronic GmbH 2022

Use of any of the text or images contained in this brochure requires written  
confirmation from Clearaudio Electronic GmbH.

Protective charge: EUR 15,-



Loving music

**Clearaudio electronic GmbH 2022**

Spardorfer Str. 150 | D-91054 Erlangen | Fon: +49.9131.40 300 100 | Fax: +49.9131.40 300 119 | [info@clearaudio.de](mailto:info@clearaudio.de)  
**Made in Germany**

[www.clearaudio.de](http://www.clearaudio.de)  
[www.analogshop.de](http://www.analogshop.de)

#220114-E  
[aufsess.com](http://aufsess.com)

Foto: Lucija Romanovska